

SECTION A-A

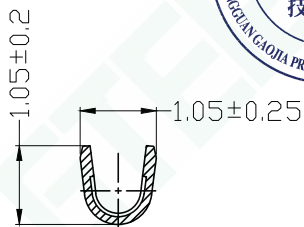

SECTION B-B

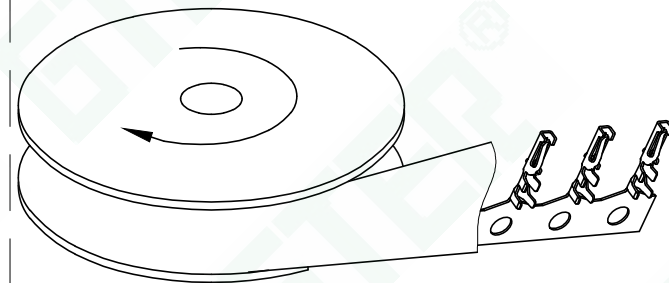

包装示意图(端子V型口向外顺时针绕盘)

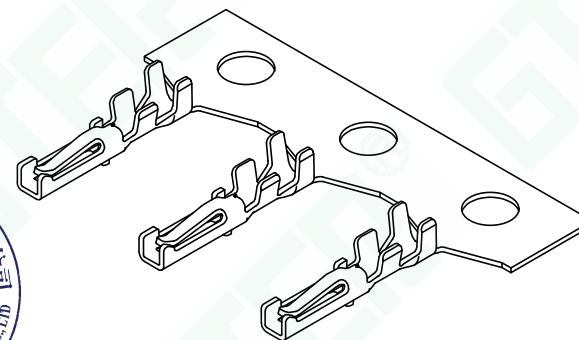

■ Main Specifications

- 接触电阻 (Contact resistance): $\leq 20m\Omega$
- 绝缘电阻 (Insulation resistance): $\geq 100M\Omega$
- 额定电压 (Rated voltage): 125V AC DC
- 额定电流 (Rated current): 1.0A AC DC
- 耐电压 (Withstand Voltage): 500V AC/minute
- 温度范围 (Temperature Range): $-25^{\circ}C \sim +85^{\circ}C$

规格表	Part No	Wire Range	Insulation O.D	Material	Finish	Qty/reel	Features(Used in)	Remark
	A1253TF-PA0	AWG#32~#28	0.90 (MAX)	Phosphor Bronze	Gold-flash	20,000	GJ-A1253 SOCKET HOUSIN SERIES	

GTER® 东莞市高嘉精密电子有限公司
DONGGUAN GJ PRECISION ELECTRONICS Co.Ltd.

PART NO:GJ-A1253TF-PTS

1.25mm WIRE TO BOARD CONNECTOR, SOCKET TERMINAL

APPROVED BY: APPROVED

CHECKED BY: CHECKED

DRAWN BY:yiliangdong

DATE:2021-11-25

A1253端子 产品图

PROJ:

UNIT: mm

SCALE: --

SHEET: 1/1 A4

VER NO: A0

TOLERANCE

-1 ±0.10

1-5 ±0.15

5-15 ±0.20

15-30 ±0.25

30- ±0.30

(ANGLE) .X ±10°

LTR

标记1

标记2

标记3

标记4

CUSTOMER:---

REVISION RECORD

修改内容1

修改内容2

修改内容3

修改内容4

NAME

姓名1

姓名2

姓名3

姓名4

DATE

日期1

日期2

日期3

日期4

Conforms to The RoHS&REACH Instruction

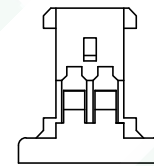
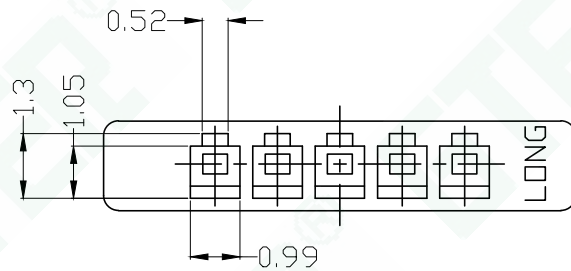
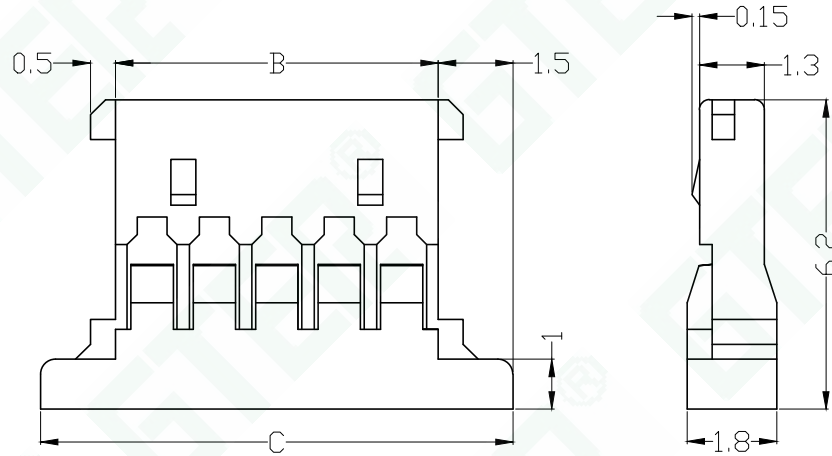
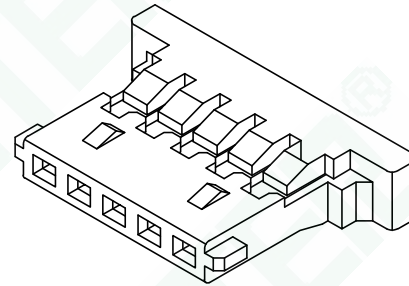
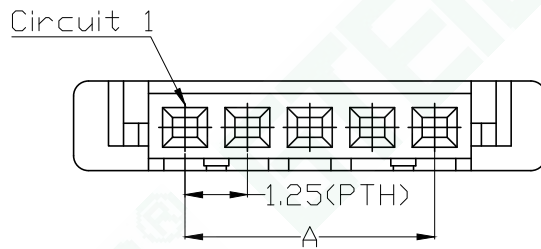

2 Circuit

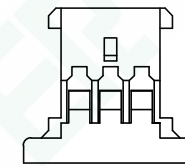

3 Circuit

■ Main Specifications

- 接触电阻 (Contact resistance): $\leq 20m\Omega$
- 绝缘电阻 (Insulation resistance): $\geq 100M\Omega$
- 额定电压 (Rated voltage): 125V AC DC
- 额定电流 (Rated current): 1.0A AC DC
- 耐电压 (Withstand Voltage): 500V AC/minute
- 温度范围 (Temperature Range): $-25^{\circ}C \sim +85^{\circ}C$

■ 产品编码简介:

GJ-A1253HF-**-AON
 ① ② ③ ④

1. 系列号;
2. 母胶壳;
3. Pin位数;
4. Nylon66 UL94V-0 (本色)

■ 适配 GJ-W1253 WAFER SERIES.

■ 适配 GJ-A1253 SOCKET TERMINAL.

Poles	Dimensions(mm)			Q'ty/ bag
	A	B	C	
2P	1.25	2.72	5.72	1,000
3P	2.50	3.97	6.97	1,000
4P	3.75	5.22	8.22	1,000
5P	5.00	6.47	9.47	1,000
6P	6.25	7.72	10.72	1,000
7P	7.50	8.97	11.97	1,000
8P	8.75	10.22	13.22	1,000
9P	10.00	11.47	14.47	1,000
10P	11.25	12.72	15.72	1,000
11P	12.50	13.97	16.97	1,000
12P	13.75	15.22	18.22	1,000
14P	16.25	17.72	20.72	1,000
15P	17.50	18.97	21.97	1,000
20P	23.75	25.22	28.22	1,000
30P	36.25	37.72	40.72	1,000

GTER® 东莞市高嘉精密电子有限公司
 DONGGUAN GJ PRECISION ELECTRONICS Co.Ltd.

PART NO:GJ-A1253HF-**-AON

1.25mm WIRE TO BOARD CONNECTOR, SOCKET HOUSING

APPROVED BY: APPROVED

CHECKED BY: CHECKED

DRAWN BY: yiliangdong

DATE: 2021-11-25

A1253母胶壳 产品图

PROJ:

UNIT: mm

SCALE: --

SHEET: 1/1 A4

VER NO: AO

TOLERANCE

-1 ±0.10

1-5 ±0.15

5-15 ±0.20

15-30 ±0.25

30- ±0.30
 (ANGLE) .X ±10°

LTR

标记1

标记2

标记3

标记4

REVISION RECORD

修改内容1

修改内容2

修改内容3

修改内容4

NAME

姓名1

姓名2

姓名3

姓名4

DATE

日期1

日期2

日期3

日期4

CUSTOMER: ---

Conforms to The RoHS&REACH Instruction

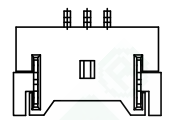
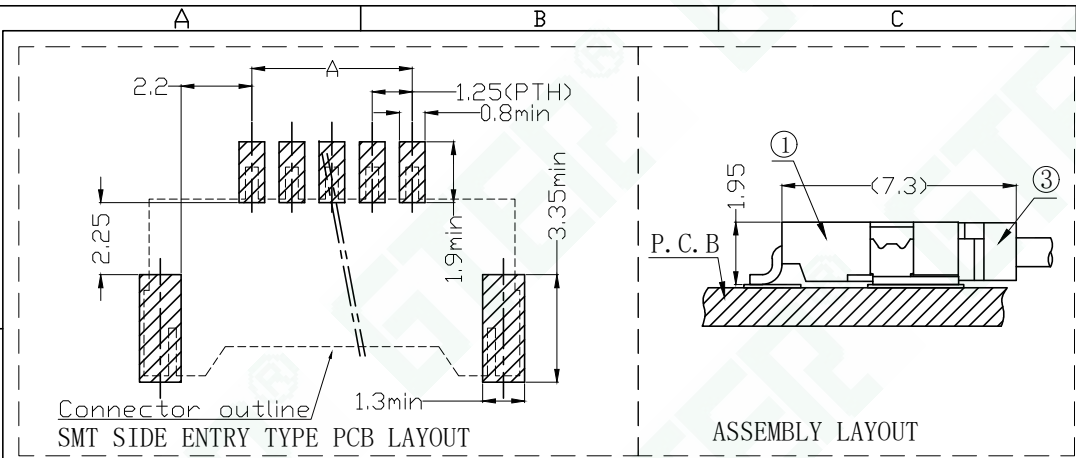

3 Circuit

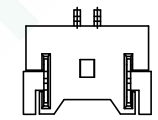

2 Circuit

■主要技术参数 Main Specifications

- 接触电阻 (Contact resistance): $\leq 20m\Omega$
- 绝缘电阻 (Insulation resistance): $\geq 100M\Omega$
- 额定电压 (Rated voltage): 50V AC DC
- 额定电流 (Rated current): 1.0A AC DC
- 耐电压 (Withstand Voltage): 500V AC/minute
- 温度范围 (Temperature Range): $-25^{\circ}C \sim +105^{\circ}C$

■产品编码简介: GJ-A1251WRS-**-FON

- ① ② ③ ④

1. 系列号;
 2. 卧式贴板针座;
 3. Pin位数;
 4. LCP UL94V-0 (本色)
- 适配 GJ-A1251 SOCKET HOUSING SERIES.

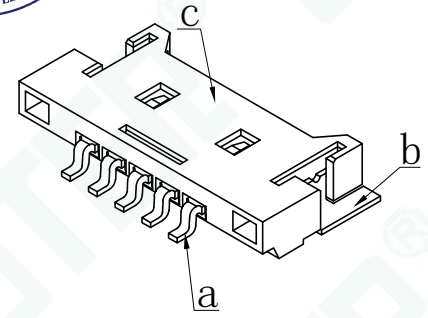
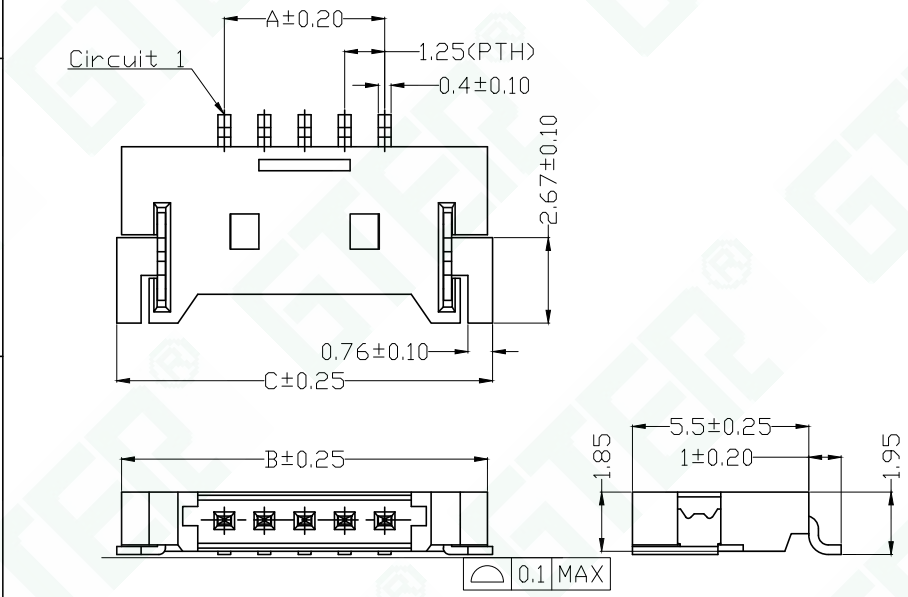

Poles	Dimensions(mm)			Q'ty/ reel
	A	B	C	
2P	1.25	7.65	7.97	1,000
3P	2.50	8.90	9.22	1,000
4P	3.75	10.15	10.47	1,000
5P	5.00	11.40	11.72	1,000
6P	6.25	12.65	12.97	1,000
7P	7.50	13.90	14.22	1,000
8P	8.75	15.15	15.47	1,000
9P	10.00	16.40	16.72	1,000
10P	11.25	17.65	17.97	1,000
11P	12.50	18.90	19.22	1,000
12P	13.75	20.15	20.47	1,000
14P	16.25	22.65	22.97	1,000
15P	17.50	23.90	24.22	1,000
20P	23.75	30.15	30.47	1,000
30P	36.25	42.65	42.97	1,000

组成序号	名称	材质
a	0.3pin针	磷铜镀高温亮锡
b	接地片	磷铜镀高温亮锡
c	WAFER 主体	LCP(本色) UL94V-0

GTER® 东莞市高嘉精密电子有限公司
DONGGUAN GJ PRECISION ELECTRONICS Co.Ltd.
PART NO: GJ-A1253WRS-**-FON
1.25mm WIRE TO BOARD CONNECTOR, WAFER(R-SMT TYPE)

APPROVED BY: APPROVED	PROJ:
CHECKED BY: CHECKED	UNIT: mm
DRAWN BY: yiliangdong	SCALE: --
DATE: 2021-11-25	SHEET: 1/1 A4
A1253卧式贴板针座产品图	VER NO: AO

TOLERANCE	LTR	REVISION RECORD	NAME	DATE
-1 ±0.10	标记1	修改内容1	姓名1	日期1
1-5 ±0.15	标记2	修改内容2	姓名2	日期2
5-15 ±0.20	标记3	修改内容3	姓名3	日期3
15-30 ±0.25	标记4	修改内容4	姓名4	日期4
30- ±0.30	CUSTOMER: ---			
(ANGLE) .X ±10°	Conforms to The RoHS&REACH Instruction			