

SECTION A-A

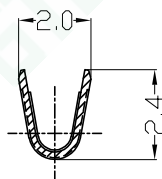

SECTION B-B

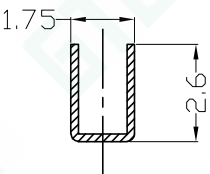

SECTION C-C

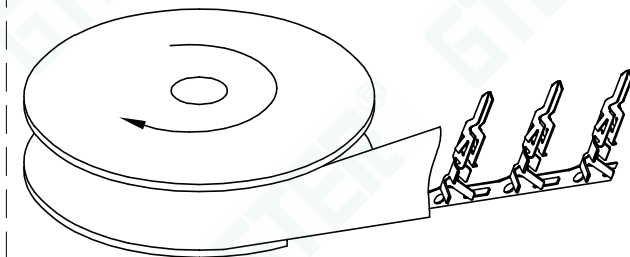

包装示意图(端子V型口向外顺时针绕盘)

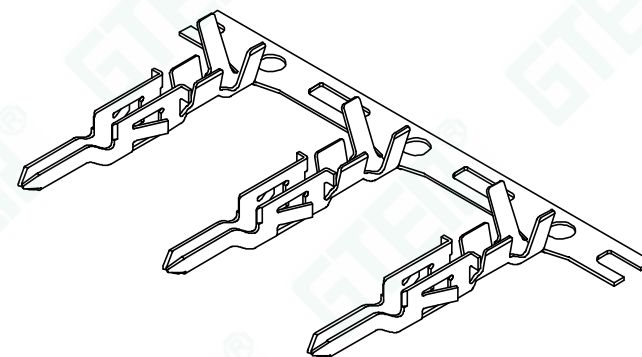

■ Main Specifications

- 额定电流 (Current rating): 9.0A AC, DC
- 额定电压 (Voltage rating): 600V AC, DC
- 温度范围 (Temperature range): -25°C TO + 85°C
- 接触电阻 (Contact resistance): ≤15MΩ
- 绝缘电阻 (Insulation resistance): ≥1000MΩ
- 耐电压 (Withstand voltage): 1500V AC/minute

规格表	Part No	Wire Range	Insulation O.D	Material	Finish	Qty/reel	Features (Used in)	Remark
	C4201TM-PTS	AWG#24~#18	3.1 (MAX)	Phosphor Bronze	Tin-plated	5,000	GJ-C4201 SOCKET HOUSIN SERIES	MX 5559T

GTER® 东莞市高嘉精密电子有限公司
DONGGUAN GJ PRECISION ELECTRONICS Co.Ltd.

PART NO: GJ-C4201TM-PTS

4.20mm WIRE TO WIRE CONNECTOR, PLUG TERMINAL

APPROVED BY: APPROVED

CHECKED BY: CHECKED

DRAWN BY: yiliangdong

DATE: 2023-10-09

C4201端子 产品图

PROJ:

UNIT: mm

SCALE: --

SHEET: 1/1 A4

VER NO: AO

TOLERANCE

-1 ±0.20

1-5 ±0.30

5-15 ±0.40

15-30 ±0.50

30- ±0.60

(ANGLE) .X ±10°

LTR

标记1

标记2

标记3

标记4

CUSTOMER: ---

REVISION RECORD

修改内容1

修改内容2

修改内容3

修改内容4

NAME

姓名1

姓名2

姓名3

姓名4

DATE

日期1

日期2

日期3

日期4

Conforms to The RoHS&REACH Instruction

5559

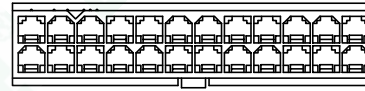
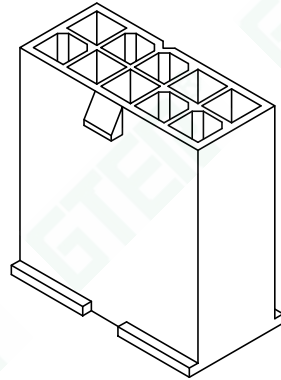
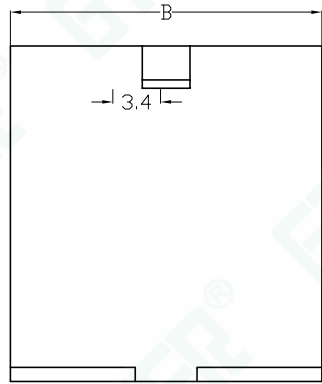
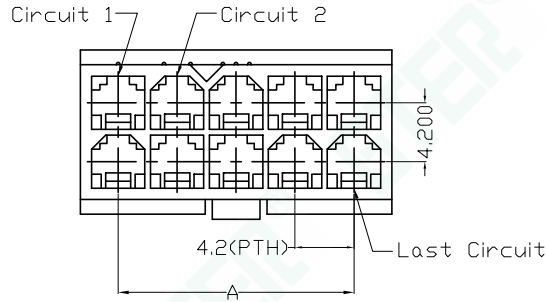

2x12P



2x01P

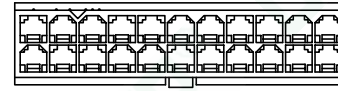

2x11P



2x02P

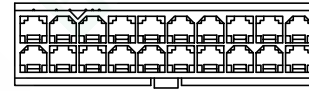

2x10P

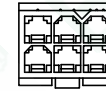

2x03P

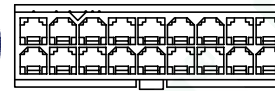

2x09P

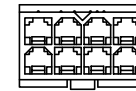

2x04P

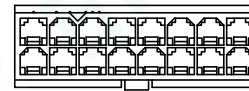

2x08P

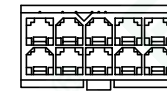

2x05P

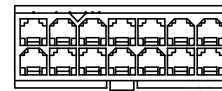

2x07P

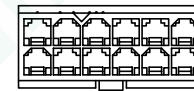

2x06P

■ Main Specifications

- 接触电阻 (Contact resistance): $\leq 20m\Omega$
- 绝缘电阻 (Insulation resistance): $\geq 1000M\Omega$
- 额定电压 (Rated voltage): 300V AC DC
- 额定电流 (Rated current): 7.0A AC DC
- 耐电压 (Withstand Voltage): 1500V AC/minute
- 温度范围 (Temperature Range): $-25^{\circ}C \sim +85^{\circ}C$

■ 产品编码简介: GJ-C4201HM-2x**-AON-A

1. 系列号; ① ② ③ ④ ⑤
 2. 空接胶壳;
 3. Pin位数, 2x02PIN~2x12PIN;
 4. AON-Nylon66 UL94V-0 (本色);
A2N-Nylon66 UL94V-2 (本色);
 5. 特征: 无翅扣A型, 选用时料号需备注。
- 适配 GJ-A4201 SOCKET HOUSING SERIES.

Poles	Dimensions(mm)		Q'ty/ bag
	A	B	
2x01P	—	5.45	1,000
2x02P	4.20	9.65	1,000
2x03P	8.40	13.85	1,000
2x04P	12.60	18.05	1,000
2x05P	16.80	22.25	1,000
2x06P	21.00	26.45	1,000
2x07P	25.20	30.65	1,000
2x08P	29.40	34.85	1,000
2x09P	33.60	39.05	1,000
2x10P	37.80	43.25	1,000
2x11P	42.00	47.45	1,000
2x12P	46.20	51.65	1,000

GTER® 东莞市高嘉精密电子有限公司
DONGGUAN GJ PRECISION ELECTRONICS Co.Ltd.

PART NO: GJ-C4201HM-2x**-***-A

4.2mm WIRE TO WIRE CONNECTOR, DUAL ROW HOUSING

APPROVED BY: APPROVED

CHECKED BY: CHECKED

DRAWN BY: yiliangdong

DATE: 2023-10-09

C4201双排A型胶壳产品图

PROJ:

UNIT: mm

SCALE: --

SHEET: 1/1 A4

VER NO: AO

TOLERANCE

-1 ±0.20

1-5 ±0.30

5-15 ±0.40

15-30 ±0.50

30- ±0.60

(ANGLE) .X ±10°

LTR

标记1

标记2

标记3

标记4

CUSTOMER: ---

REVISION RECORD

修改内容1

修改内容2

修改内容3

修改内容4

NAME DATE

姓名1 日期1

姓名2 日期2

姓名3 日期3

姓名4 日期4

Conforms to The RoHS&REACH Instruction

5559

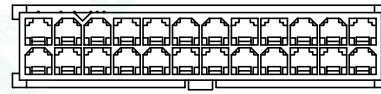
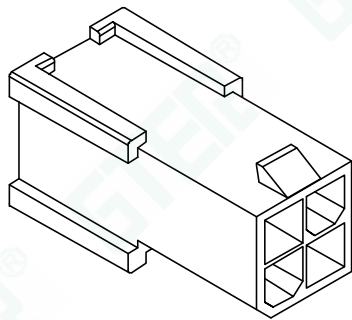
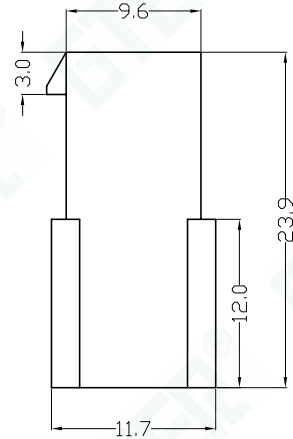
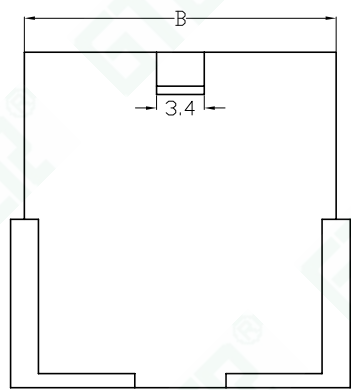
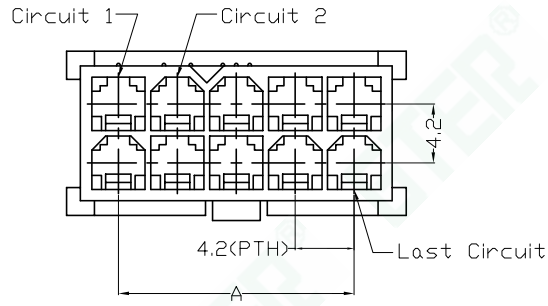

2x12P



2x01P

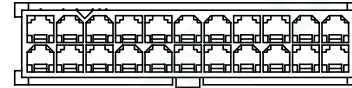

2x11P



2x02P

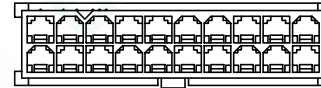

2x10P

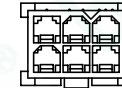

2x03P

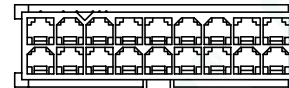

2x09P

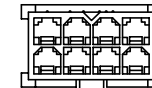

2x04P

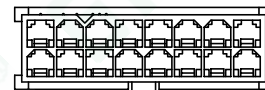

2x08P

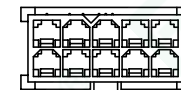

2x05P

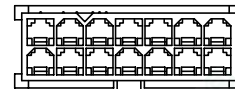

2x07P

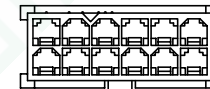

2x06P

■ Main Specifications

- . 接触电阻 (Contact resistance): $\leq 20m\Omega$
- . 绝缘电阻 (Insulation resistance): $\geq 1000M\Omega$
- . 额定电压 (Rated voltage): 300V AC DC
- . 额定电流 (Rated current): 7.0A AC DC
- . 耐电压 (Withstand Voltage): 1500V AC/minute
- . 温度范围 (Temperature Range): $-25^{\circ}C \sim +85^{\circ}C$

■ 产品编码简介: GJ-C4201HM-2x**-AON-B

1. 系列号; ① ② ③ ④ ⑤
 2. 空接胶壳;
 3. Pin位数, 2x02PIN~2x12PIN;
 4. AON-Nylon66 UL94V-0 (本色);
A2N-Nylon66 UL94V-2 (本色);
 5. 特征: 无翅扣B型, 选用时料号需备注。
- 适配 GJ-A4201 SOCKET HOUSING SERIES.

Poles	Dimensions(mm)		Q'ty/ bag
	A	B	
2x01P	—	5.45	1,000
2x02P	4.20	9.65	1,000
2x03P	8.40	13.85	1,000
2x04P	12.60	18.05	1,000
2x05P	16.80	22.25	1,000
2x06P	21.00	26.45	1,000
2x07P	25.20	30.65	1,000
2x08P	29.40	34.85	1,000
2x09P	33.60	39.05	1,000
2x10P	37.80	43.25	1,000
2x11P	42.00	47.45	1,000
2x12P	46.20	51.65	1,000

GTER® 东莞市高嘉精密电子有限公司
DONGGUAN GJ PRECISION ELECTRONICS Co.Ltd.

PART NO: GJ-C4201HM-2x**-***-B

4.2mm WIRE TO WIRE CONNECTOR, DUAL ROW HOUSING

APPROVED BY: APPROVED

CHECKED BY: CHECKED

DRAWN BY: yiliangdong

DATE: 2023-10-09

C4201双排B型胶壳产品图

PROJ:

UNIT: mm

SCALE: --

SHEET: 1/1 A4

VER NO: AO

TOLERANCE

-1 ±0.20

1-5 ±0.30

5-15 ±0.40

15-30 ±0.50

30- ±0.60

(ANGLE) .X ±10°

LTR

标记1

标记2

标记3

标记4

REVISION RECORD

修改内容1

修改内容2

修改内容3

修改内容4

NAME DATE

姓名1 日期1

姓名2 日期2

姓名3 日期3

姓名4 日期4

CUSTOMER: ---

Conforms to The RoHS&REACH Instruction

5559

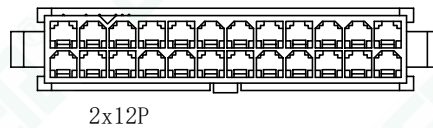
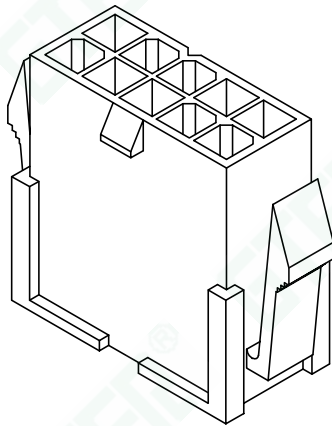
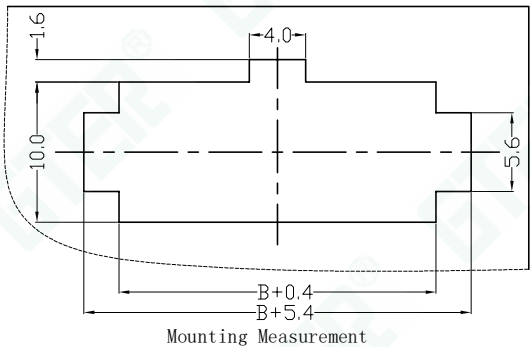
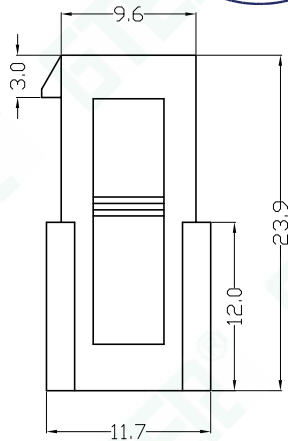
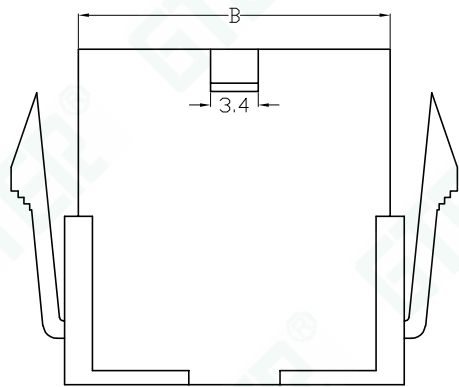
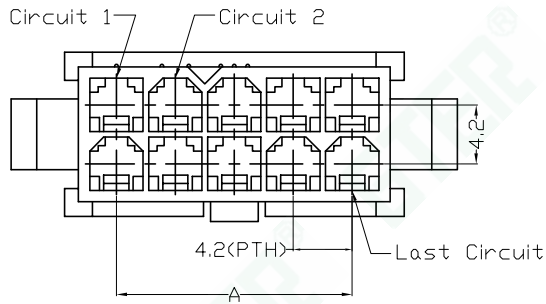

2x12P

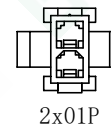

2x01P

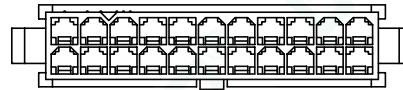

2x11P

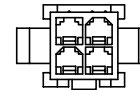

2x02P

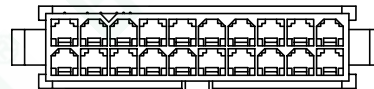

2x10P

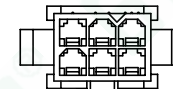

2x03P

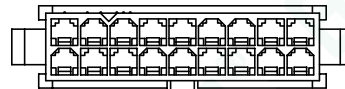

2x09P

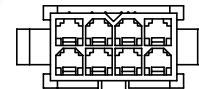

2x04P

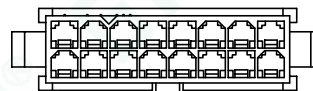

2x08P

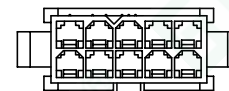

2x05P

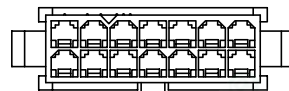

2x07P

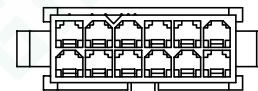

2x06P

■ Main Specifications

- . 接触电阻 (Contact resistance): $\leq 20m\Omega$
- . 绝缘电阻 (Insulation resistance): $\geq 1000M\Omega$
- . 额定电压 (Rated voltage): 300V AC DC
- . 额定电流 (Rated current): 7.0A AC DC
- . 耐电压 (Withstand Voltage): 1500V AC/minute
- . 温度范围 (Temperature Range): $-25^{\circ}C \sim +85^{\circ}C$
- 适用基板厚度 Applicable PC board thickness: 1.6 to 2.0mm

■ 产品编码简介: GJ-C4201HM-2x**-AON-WD

① ② ③ ④ ⑤

1. 系列号;
2. 空接胶壳;
3. Pin位数, 2x02PIN~2x12PIN;
4. AON-NyLon66 UL94V-0 (本色);
A2N-NyLon66 UL94V-2 (本色);
5. 特征: WD-带翅扣, 选用时料号需备注。

■ 适配 GJ-A4201 SOCKET HOUSING SERIES.

Poles	Dimensions(mm)		Q'ty/ bag
	A	B	
2x01P	—	5.45	1,000
2x02P	4.20	9.65	1,000
2x03P	8.40	13.85	1,000
2x04P	12.60	18.05	1,000
2x05P	16.80	22.25	1,000
2x06P	21.00	26.45	1,000
2x07P	25.20	30.65	1,000
2x08P	29.40	34.85	1,000
2x09P	33.60	39.05	1,000
2x10P	37.80	43.25	1,000
2x11P	42.00	47.45	1,000
2x12P	46.20	51.65	1,000

GTER® 东莞市高嘉精密电子有限公司
DONGGUAN GJ PRECISION ELECTRONICS Co.Ltd.

PART NO: GJ-C4201HM-2x**-***-WD

4.2mm WIRE TO WIRE CONNECTOR, DUAL ROW HOUSING

APPROVED BY: APPROVED

CHECKED BY: CHECKED

DRAWN BY: yiliangdong

DATE: 2023-10-09

C4201双排带翅扣胶壳产品图

PROJ:

UNIT: mm

SCALE: --

SHEET: 1/1 A4

VER NO: AO

TOLERANCE

-1 ±0.20

1-5 ±0.30

5-15 ±0.40

15-30 ±0.50

30- ±0.60

(ANGLE) .X ±10°

LTR

标记1

标记2

标记3

标记4

REVISION RECORD

修改内容1

修改内容2

修改内容3

修改内容4

NAME

姓名1

姓名2

姓名3

姓名4

DATE

日期1

日期2

日期3

日期4

CUSTOMER: ---

Conforms to The RoHS&REACH Instruction

5559

A B C D E F

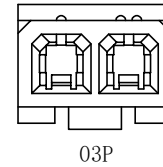
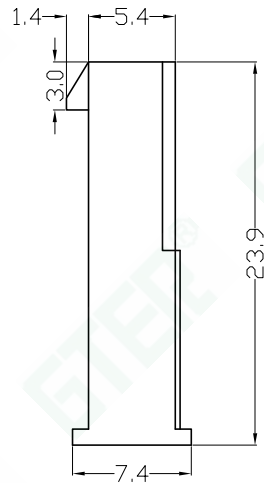
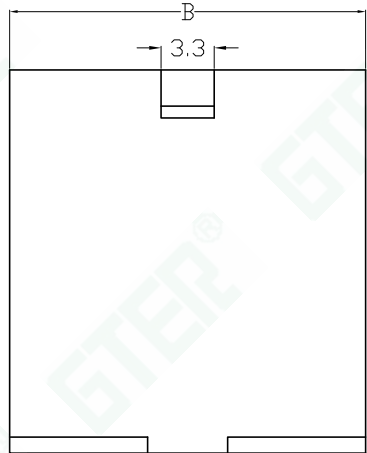
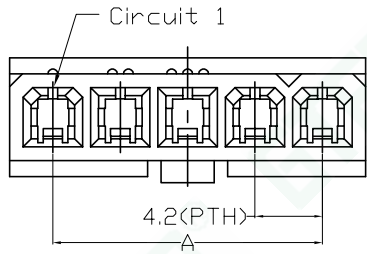

03P

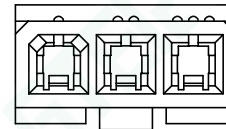

03P

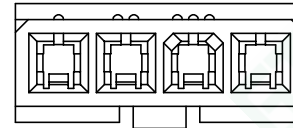

04P

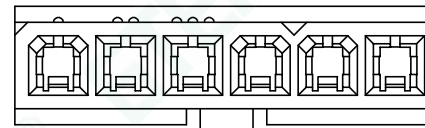

06P

■ Main Specifications

- 接触电阻 (Contact resistance): $\leq 20m\Omega$
- 绝缘电阻 (Insulation resistance): $\geq 1000M\Omega$
- 额定电压 (Rated voltage): 300V AC DC
- 额定电流 (Rated current): 7.0A AC DC
- 耐电压 (Withstand Voltage): 1500V AC/minute
- 温度范围 (Temperature Range): $-25^{\circ}C \sim +85^{\circ}C$

■ 产品编码简介: GJ-C4201HM-**-AON-A

① ② ③ ④ ⑤

1. 系列号;
2. 空接型胶壳;
3. Pin位数, 02PIN~06PIN;
4. AON-Nylon66 UL94V-0 (本色);
A2N-Nylon66 UL94V-2 (本色);
5. 特征: 无翅扣A型, 选用时料号需备注。

■ 适配 GJ-A4201 SOCKET HOUSING SERIES.

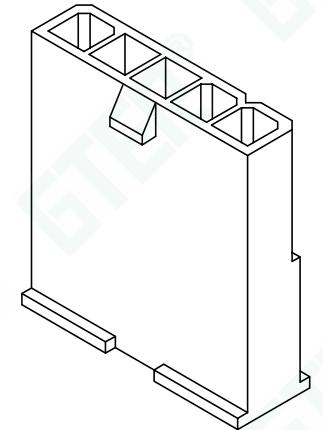

Poles	Dimensions(mm)		Q'ty/ bag
	A	B	
02P	4.20	9.65	1,000
03P	8.40	13.85	1,000
04P	12.60	18.05	1,000
05P	16.80	22.25	1,000
06P	21.00	26.45	1,000

GTER® 东莞市高嘉精密电子有限公司
DONGGUAN GJ PRECISION ELECTRONICS Co.Ltd.

PART NO: GJ-C4201HM-**-***-A

4.2mm WIRE TO WIRE CONNECTOR, SINGLE ROW HOUSING

APPROVED BY: APPROVED

CHECKED BY: CHECKED

DRAWN BY: yiliangdong

DATE: 2023-10-09

C4201单排A型胶壳产品图

PROJ:

UNIT: mm

SCALE: --

SHEET: 1/1 A4

VER NO: AO

TOLERANCE

-1 ±0.20

1-5 ±0.30

5-15 ±0.40

15-30 ±0.50

30- ±0.60

(ANGLE) .X ±10°

LTR

标记1

标记2

标记3

标记4

REVISION RECORD

修改内容1

修改内容2

修改内容3

修改内容4

NAME

姓名1

姓名2

姓名3

姓名4

DATE

日期1

日期2

日期3

日期4

CUSTOMER: ---

Conforms to The RoHS&REACH Instruction

A B C D E F

5559

A B C D E F

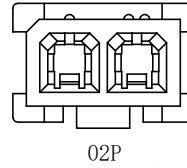
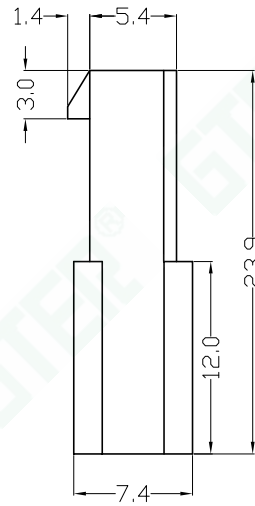
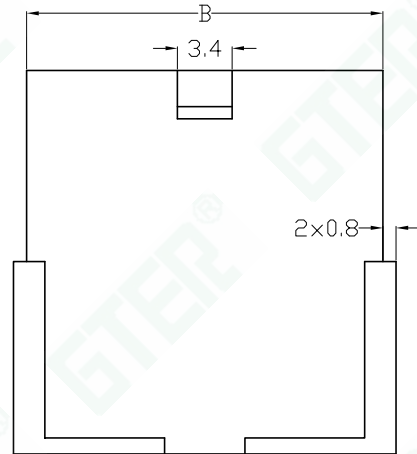
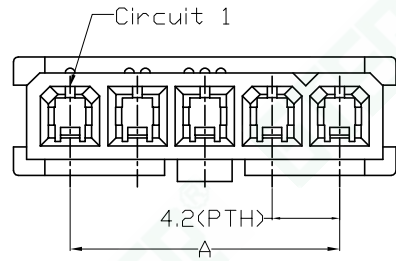

02P

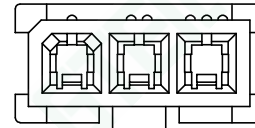

03P

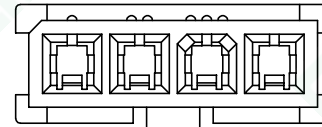

04P

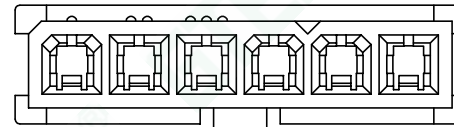

06P

■ Main Specifications

- 接触电阻 (Contact resistance): $\leq 20m\Omega$
- 绝缘电阻 (Insulation resistance): $\geq 1000M\Omega$
- 额定电压 (Rated voltage): 300V AC DC
- 额定电流 (Rated current): 7.0A AC DC
- 耐电压 (Withstand Voltage): 1500V AC/minute
- 温度范围 (Temperature Range): $-25^{\circ}C \sim +85^{\circ}C$

■ 产品编码简介: GJ-C4201HM-**-AON-B

① ② ③ ④ ⑤

1. 系列号;
 2. 空接胶壳;
 3. Pin位数, 02PIN~06PIN;
 4. A0N-Nylon66 UL94V-0 (本色);
A2N-Nylon66 UL94V-2 (本色);
 5. 特征: 无翅扣B型, 选用时料号需备注。
- 适配 GJ-A4201 SOCKET HOUSING SERIES.

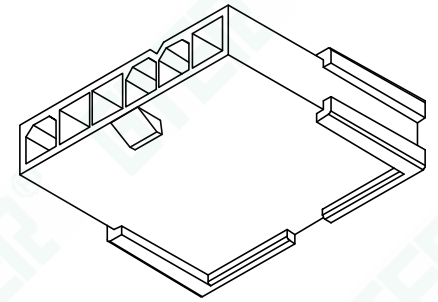

Poles	Dimensions(mm)		Q'ty/ bag
	A	B	
02P	4.20	9.65	1,000
03P	8.40	13.85	1,000
04P	12.60	18.05	1,000
05P	16.80	22.25	1,000
06P	21.00	26.45	1,000

GTER® 东莞市高嘉精密电子有限公司
DONGGUAN GJ PRECISION ELECTRONICS Co.Ltd.

PART NO: GJ-C4201HM-**-***-B

4.2mm WIRE TO WIRE CONNECTOR, SINGLE ROW HOUSING

APPROVED BY: APPROVED

CHECKED BY: CHECKED

DRAWN BY: yiliangdong

DATE: 2023-10-09

C4201单排B型胶壳产品图

PROJ:

UNIT: mm

SCALE: --

SHEET: 1/1 A4

VER NO: AO

TOLERANCE

-1 ± 0.20

1-5 ± 0.30

5-15 ± 0.40

15-30 ± 0.50

30- ± 0.60

(ANGLE) .X $\pm 10^{\circ}$

LTR

标记1

标记2

标记3

标记4

CUSTOMER: ---

REVISION RECORD

修改内容1

修改内容2

修改内容3

修改内容4

NAME DATE

姓名1 日期1

姓名2 日期2

姓名3 日期3

姓名4 日期4

Conforms to The RoHS&REACH Instruction

A B C D E F

5559

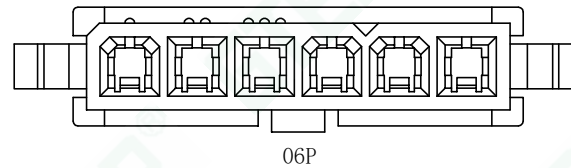
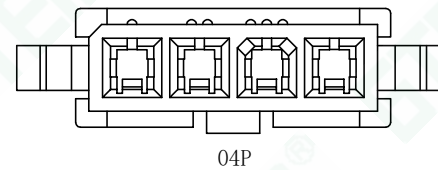
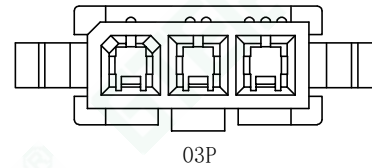
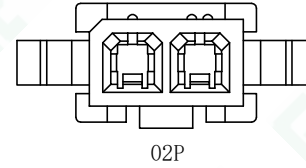
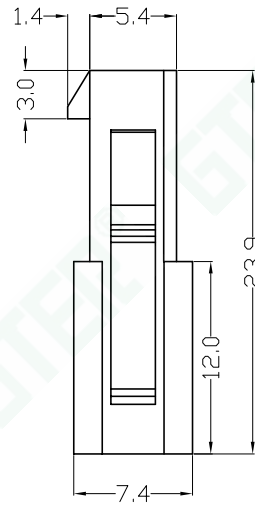
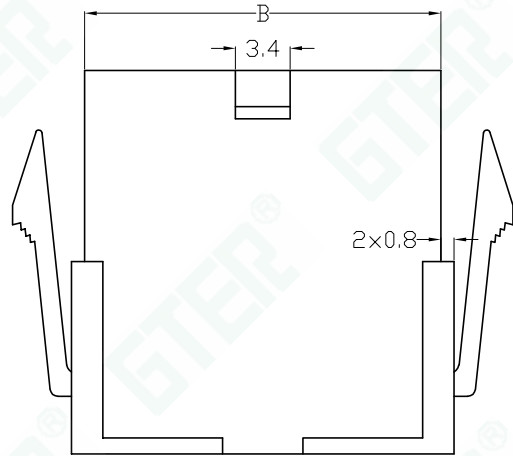
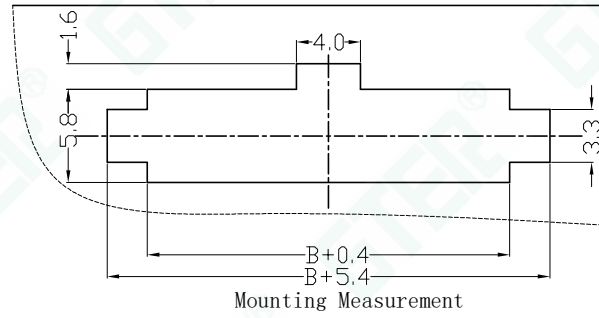
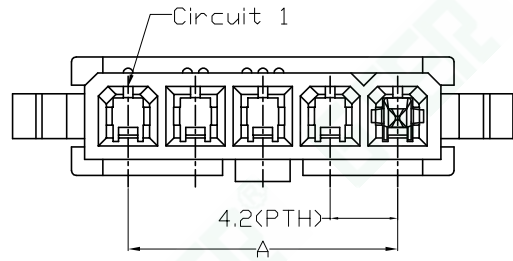

■ Main Specifications

- 接触电阻 (Contact resistance): $\leq 20m\Omega$
- 绝缘电阻 (Insulation resistance): $\geq 1000M\Omega$
- 额定电压 (Rated voltage): 300V AC DC
- 额定电流 (Rated current): 7.0A AC DC
- 耐电压 (Withstand Voltage): 1500V AC/minute
- 温度范围 (Temperature Range): $-25^{\circ}C \sim +85^{\circ}C$
- 适用基板厚度 Applicable PC board thickness: 1.6 to 2.0mm

■ 产品编码简介: GJ-C4201HM-**-AON-WD

1. 系列号; ① ② ③ ④ ⑤
2. 空接胶壳;
3. Pin位数, 02PIN~06PIN;
4. AON-Nylon66 UL94V-0 (本色);
A2N-Nylon66 UL94V-2 (本色);
5. 特征: WD-带翅扣, 选用时料号需备注。

■ 适配 GJ-A4201 SOCKET HOUSING SERIES.

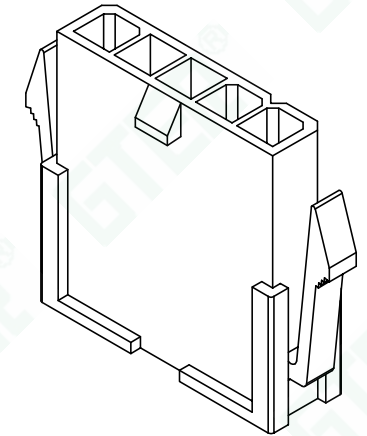

Poles	Dimensions(mm)		Q'ty/ bag
	A	B	
02P	4.20	9.65	1,000
03P	8.40	13.85	1,000
04P	12.60	18.05	1,000
05P	16.80	22.25	1,000
06P	21.00	26.45	1,000

GTER® 东莞市高嘉精密电子有限公司
DONGGUAN GJ PRECISION ELECTRONICS Co.Ltd.

PART NO: GJ-C4201HM-**-***-WD

4.2mm WIRE TO WIRE CONNECTOR, SINGLE ROW HOUSING

APPROVED BY: APPROVED

CHECKED BY: CHECKED

DRAWN BY: yiliangdong

DATE: 2023-10-09

PROJ:

UNIT: mm

SCALE: --

SHEET: 1/1 A4

VER NO: AO

TOLERANCE

-1 ±0.20

1-5 ±0.30

5-15 ±0.40

15-30 ±0.50

30- ±0.60

(ANGLE) .X ±10°

LTR

标记1

标记2

标记3

标记4

CUSTOMER: ---

REVISION RECORD

修改内容1

修改内容2

修改内容3

修改内容4

NAME DATE

姓名1 日期1

姓名2 日期2

姓名3 日期3

姓名4 日期4

Conforms to The RoHS&REACH Instruction