

包装示意图(端子V型口向外顺时针绕盘)

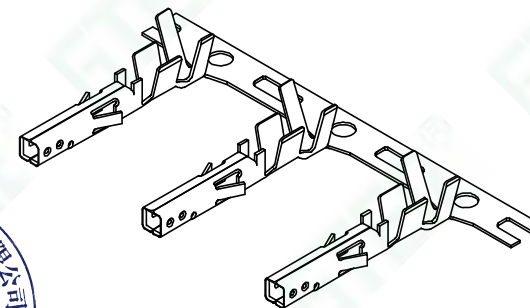

■ Main Specifications

- 额定电流 (Current rating): 9.0A AC, DC
- 额定电压 (Voltage rating): 600V AC, DC
- 温度范围 (Temperature range): -25°C TO + 85°C
- 接触电阻 (Contact resistance): ≤15MΩ
- 绝缘电阻 (Insulation resistance): ≥1000MΩ
- 耐电压 (Withstand voltage): 1500V AC/minute

规格表	Part No	Wire Range	Insulation O.D	Material	Finish	Qty/reel	Features (Used in)	Remark
	A4201TF-BTS	AWG#24~#18	3.1 (MAX)	Brasses	Tin-plated	6,000	GJ-A4201 SOCKET HOUSIN SERIES	5557-T-高脚

**GTER**® 东莞市高嘉精密电子有限公司  
DONGGUAN GJ PRECISION ELECTRONICS Co.Ltd.

PART NO: GJ-A4201TF-BTS

4.20mm WIRE TO BOARD CONNECTOR, SOCKET TERMINAL

APPROVED BY: APPROVED

CHECKED BY: CHECKED

DRAWN BY: yiliangdong

DATE: 2023-05-26

A4201端子 产品图

PROJ:

UNIT: mm

SCALE: --

SHEET: 1/1 A4

VER NO: AO

TOLERANCE

-1 ±0.20

1-5 ±0.30

5-15 ±0.40

15-30 ±0.50

30- ±0.60

(ANGLE) .X ±10°

LTR

标记1

标记2

标记3

标记4

CUSTOMER: ---

REVISION RECORD

修改内容1

修改内容2

修改内容3

修改内容4

NAME

姓名1

姓名2

姓名3

姓名4

DATE

日期1

日期2

日期3

日期4

Conforms to The RoHS&REACH Instruction

PITCH=8.6

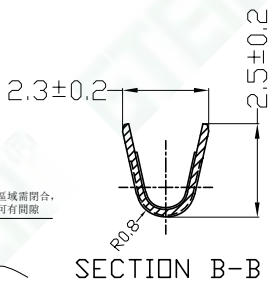
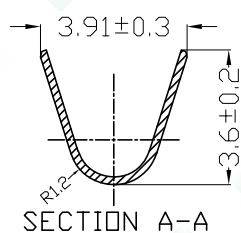
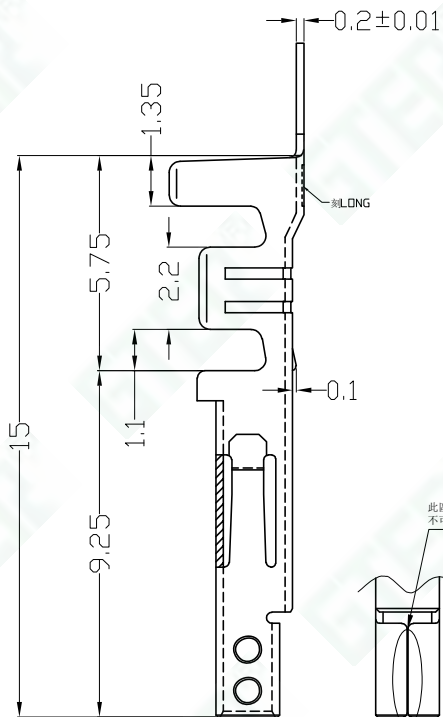
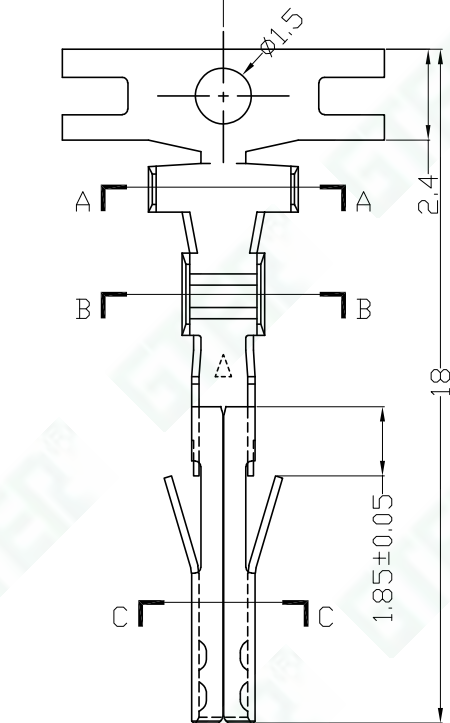

SECTION C-C

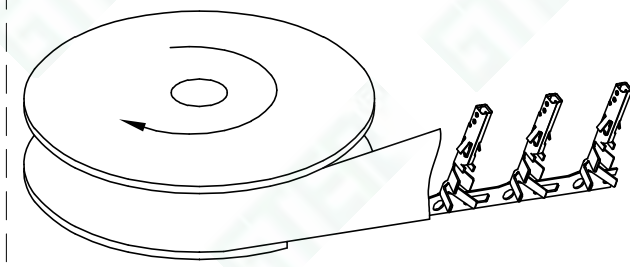

包装示意图 (端子V型口向外顺时针绕盘)

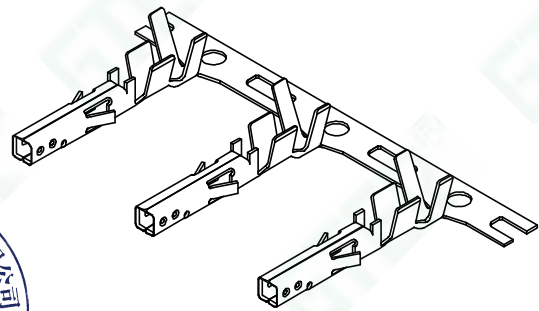

■ Main Specifications

- 额定电流 (Current rating): 9.0A AC, DC
- 额定电压 (Voltage rating): 600V AC, DC
- 温度范围 (Temperature range): -25°C TO + 85°C
- 接触电阻 (Contact resistance): ≤30MΩ
- 绝缘电阻 (Insulation resistance): ≥1000MΩ
- 耐电压 (Withstand voltage): 1500V AC/minute

规格表	Part No	Wire Range	Insulation O.D	Material	Finish	Qty/reel	Features (Used in)	Remark
	A4201TF-PTS	AWG#22~#18	2.8 (MAX)	Brasses	Tin-plated	6,000	GJ-A4201 SOCKET HOUSIN SERIES	

**GTER**® 东莞市高嘉精密电子有限公司  
DONGGUAN GJ PRECISION ELECTRONICS Co.Ltd.

PART NO: GJ-A4201TF-PTS

4. 20mm WIRE TO BOARD CONNECTOR, SOCKET TERMINAL

APPROVED BY: APPROVED  
CHECKED BY: CHECKED  
DRAWN BY: yiliangdong  
DATE: 2023-06-09  
A4201端子 产品图

PROJ: UNIT: mm  
SCALE: --  
SHEET: 1/1 A4  
VER NO: AO

TOLERANCE	LTR	REVISION RECORD	NAME	DATE
-1 ±0.20	标记1	修改内容1	姓名1	日期1
1-5 ±0.30	标记2	修改内容2	姓名2	日期2
5-15 ±0.40	标记3	修改内容3	姓名3	日期3
15-30 ±0.50	标记4	修改内容4	姓名4	日期4
30- ±0.60	CUSTOMER: ---			
(ANGLE) .X ±10°	Conforms to The RoHS&REACH Instruction			

5557

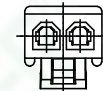
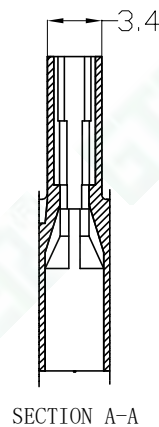
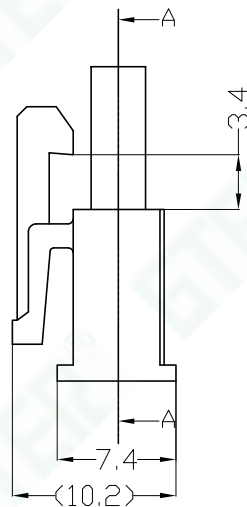
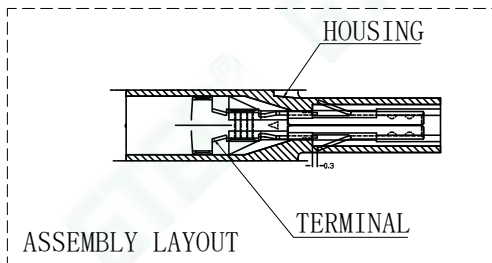
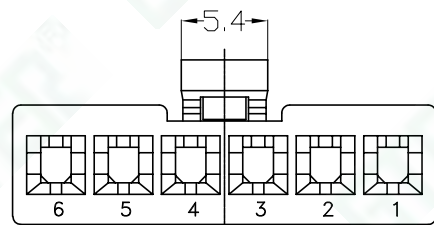
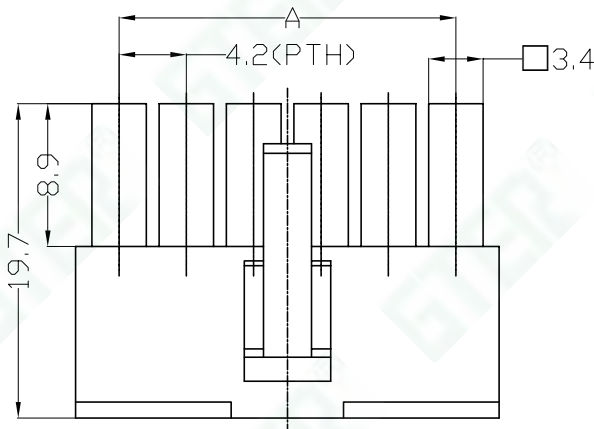
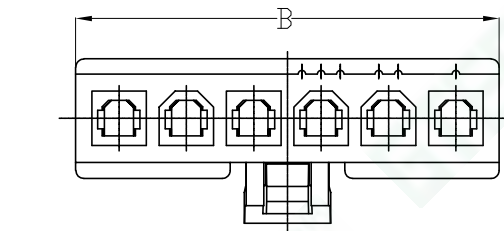

02 P(2圆)

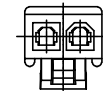

02 P

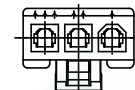

03 P

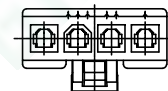

04 P

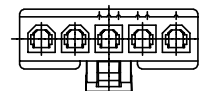

05 P

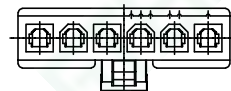

06 P

■ Main Specifications

- 接触电阻 (Contact resistance):  $\leq 20m\Omega$
- 绝缘电阻 (Insulation resistance):  $\geq 1000M\Omega$
- 额定电压 (Rated voltage): 300V AC DC
- 额定电流 (Rated current): 7.0A AC DC
- 耐电压 (Withstand Voltage): 1500V AC/minute
- 温度范围 (Temperature Range):  $-25^{\circ}C \sim +85^{\circ}C$

■ 产品编码简介: GJ-A4201HF-\*\*-AON-\*\*

① ② ③ ④ ⑤

1. 系列号;
2. 公胶壳;
3. Pin位数, 01PIN~06PIN;
4. AON-Nylon66 UL94V-0 (本色);  
A2N-Nylon66 UL94V-2 (本色);
5. 特殊规格, 文字说明.

■ 适配 GJ-A4201 SOCKET TERMINAL;

■ 适配 GJ-A4201 WAFER SERIES;  
GJ-C4201 WAFER SERIES.

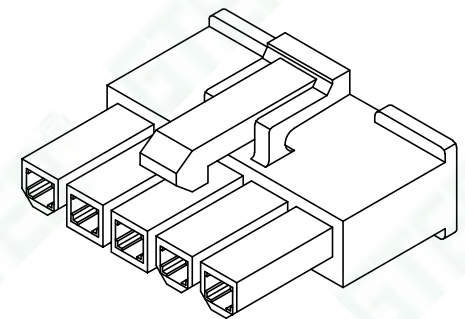

Poles	Dimensions(mm)		Q'ty/ bag
	A	B	
02P	4.20	9.60	1,000
03P	8.40	13.80	1,000
04P	12.60	18.00	1,000
05P	16.80	22.20	1,000
06P	21.00	26.40	1,000

5557

**GTER**® 东莞市高嘉精密电子有限公司  
DONGGUAN GJ PRECISION ELECTRONICS Co.Ltd.

PART NO: GJ-A4201HF-\*\*-\*\*\*

4.2mm WIRE TO BOARD CONNECTOR, SOCKET HOUSING

APPROVED BY: APPROVED

CHECKED BY: CHECKED

DRAWN BY: yiliangdong

DATE: 2022-11-18

A4201单排胶壳 产品图

PROJ:

UNIT: mm

SCALE: --

SHEET: 1/1 A4

VER NO: AO

TOLERANCE

-1 ±0.20

1-5 ±0.30

5-15 ±0.40

15-30 ±0.50

30- ±0.60

(ANGLE) .X ±10°

LTR

标记1

标记2

标记3

标记4

CUSTOMER: ---

REVISION RECORD

NAME

姓名1

姓名2

姓名3

姓名4

DATE

日期1

日期2

日期3

日期4

Conforms to The RoHS&REACH Instruction



5557

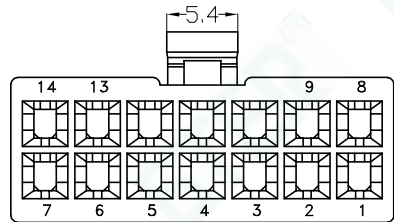
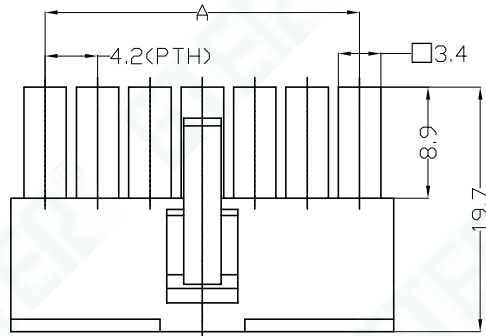
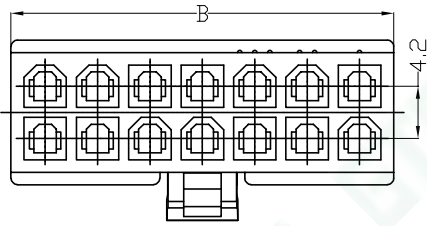

BACK VIEW

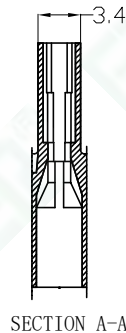

SECTION A-A

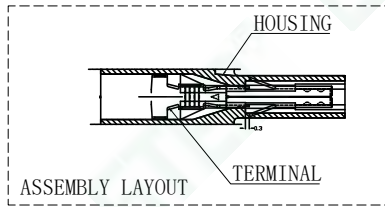

ASSEMBLY LAYOUT

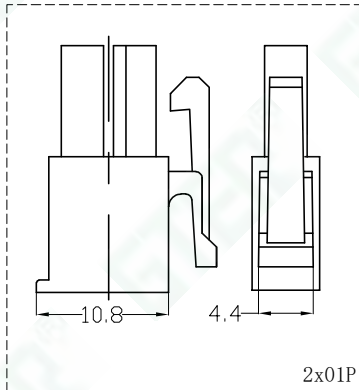
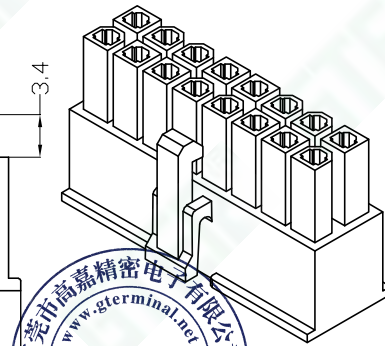

2x01P

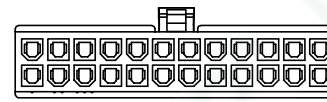

2x12P



2x01P

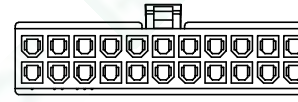

2x11P

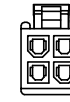

2x02P

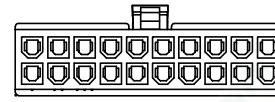

2x10P



2x03P

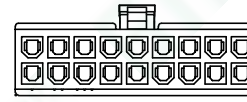

2x09P

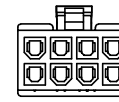

2x04P

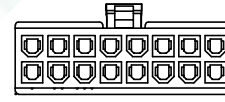

2x08P

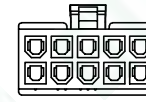

2x05P

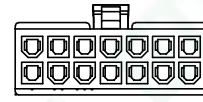

2x07P

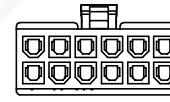

2x06P

■ Main Specifications

- 接触电阻 (Contact resistance):  $\leq 20m\Omega$
- 绝缘电阻 (Insulation resistance):  $\geq 1000M\Omega$
- 额定电压 (Rated voltage): 300V AC DC
- 额定电流 (Rated current): 7.0A AC DC
- 耐电压 (Withstand Voltage): 1500V AC/minute
- 温度范围 (Temperature Range):  $-25^{\circ}C \sim +85^{\circ}C$

■ 产品编码简介: GJ-A4201HF-\*x\*\*-AON-\*\*

① ② ③ ④ ⑤

1. 系列号;
2. 公胶壳;
3. Pin位数, 2x01PIN~2x12PIN;
4. AON-NyLon66 UL94V-0 (本色);  
A2N-NyLon66 UL94V-2 (本色);
5. 特殊规格, 文字说明.

■ 适配 GJ-A4201 SOCKET TERMINAL;

■ 适配 GJ-A4201 WAFER SERIES;  
GJ-C4201 WAFER SERIES.



2x03P (2方4圆)

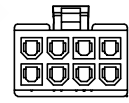

2x04P (3方5圆)

Poles	Dimensions(mm)		Q'ty/ bag
	A	B	
2x01P	—	5.60	1,000
2x02P	4.20	9.80	1,000
2x03P	8.40	14.00	1,000
2x04P	12.60	18.20	1,000
2x05P	16.80	22.40	1,000
2x06P	21.00	26.60	1,000
2x07P	25.20	30.80	1,000
2x08P	29.40	35.00	1,000
2x09P	33.60	39.20	1,000
2x10P	37.80	43.40	1,000
2x11P	42.00	47.60	1,000
2x12P	46.20	51.80	1,000

**GTER**® 东莞市高嘉精密电子有限公司  
DONGGUAN GJ PRECISION ELECTRONICS Co.Ltd.

PART NO: GJ-A4201HF-2x\*\*-\*\*

4.2mm WIRE TO BOARD CONNECTOR, SOCKET HOUSING

APPROVED BY: APPROVED

CHECKED BY: CHECKED

DRAWN BY: yiliangdong

DATE: 2022-11-12

A4201双排胶壳 产品图

PROJ:

UNIT: mm

SCALE: --

SHEET: 1/1 A4

VER NO: AO

TOLERANCE

-1 ±0.20

1-5 ±0.30

5-15 ±0.40

15-30 ±0.50

30- ±0.60

(ANGLE) .X ±10°

LTR

标记1

标记2

标记3

标记4

CUSTOMER: ---

REVISION RECORD

修改内容1

修改内容2

修改内容3

修改内容4

NAME DATE

姓名1

姓名2

姓名3

姓名4

日期1

日期2

日期3

日期4

Conforms to The RoHS&REACH Instruction

5569

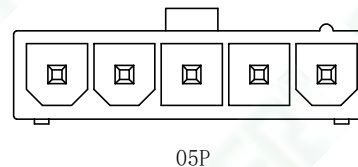
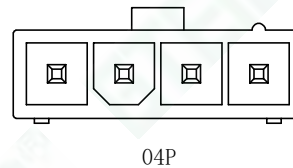
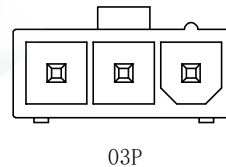
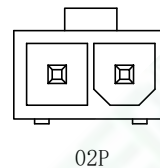
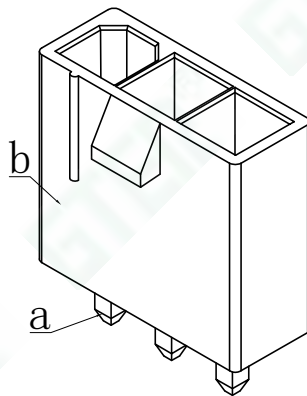
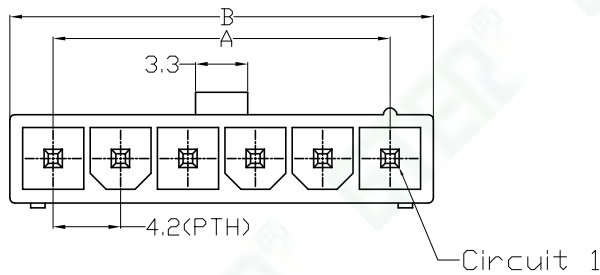

■ Main Specifications

- 接触电阻 (Contact resistance):  $\leq 20m\Omega$
- 绝缘电阻 (Insulation resistance):  $\geq 1000M\Omega$
- 额定电压 (Rated voltage): 300V AC DC
- 额定电流 (Rated current): 7.0A AC DC
- 耐电压 (Withstand Voltage): 1500V AC/minute
- 温度范围 (Temperature Range):  $-25^{\circ}C \sim +85^{\circ}C$

■ 产品编码简介: GJ-A4201WVD-\*\*-A0N

1. 系列号; ① ② ③ ④
  2. 卧式插板针座;
  3. Pin位数, 02PIN~06PIN;
  4. A0N-Nylon66 UL94V-0 (本色);  
A2N-Nylon66 UL94V-2 (本色);
- 适配 GJ-A4201 SOCKET HOUSING SERIES.

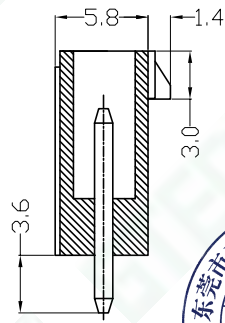
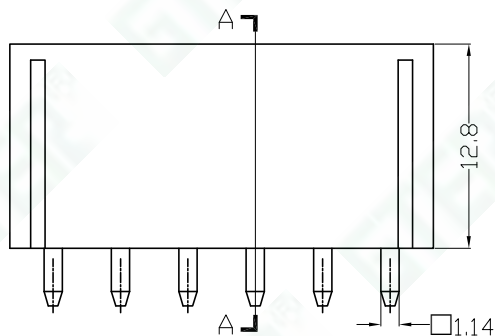

SECTION A-A

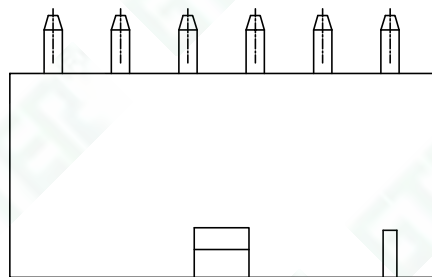
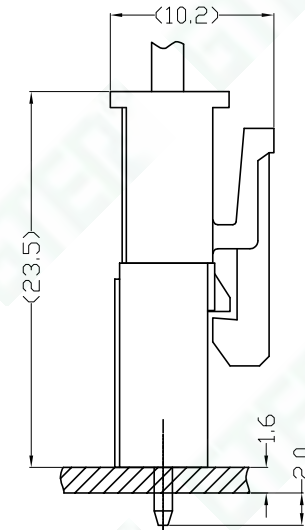

BACK VIEW

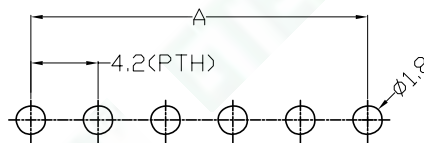

PCB LAYOUT

Poles	Dimensions(mm)		Q'ty/ bag
	A	B	
02P	4.20	9.60	1,000
03P	8.40	13.80	1,000
04P	12.60	18.00	1,000
05P	16.80	22.20	1,000
06P	21.00	26.40	1,000

组成序号	名称	材质
a	1.14方pin针	青铜镀亮锡
b	胶壳本体	Nylon66 (本色)

**GTER**® 东莞市高嘉精密电子有限公司  
DONGGUAN GJ PRECISION ELECTRONICS Co.Ltd.

PART NO: GJ-A4201WVD-\*\*-\*\*\*

4.2mm WIRE TO BOARD CONNECTOR, SOCKET HOUSING

APPROVED BY: APPROVED

CHECKED BY: CHECKED

DRAWN BY: yiliangdong

DATE: 2022-11-21

A4201单排立插产品图

PROJ: UNIT: mm

SCALE: --

SHEET: 1/1 A4

SHEET: 1/1 A4

VER NO: AO

TOLERANCE

-1 ±0.20

1-5 ±0.30

5-15 ±0.40

15-30 ±0.50

30- ±0.60

(ANGLE) .X ±10°

LTR

标记1

标记2

标记3

标记4

CUSTOMER: ---

REVISION RECORD

修改内容1

修改内容2

修改内容3

修改内容4

NAME

姓名1

姓名2

姓名3

姓名4

DATE

日期1

日期2

日期3

日期4

Conforms to The RoHS&REACH Instruction

5569

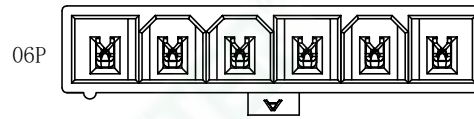
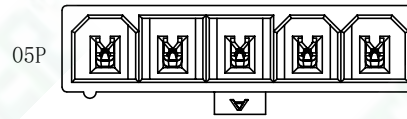
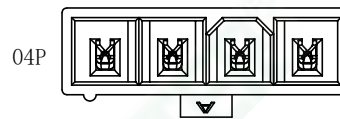
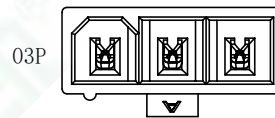
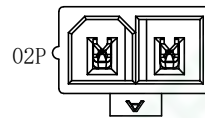
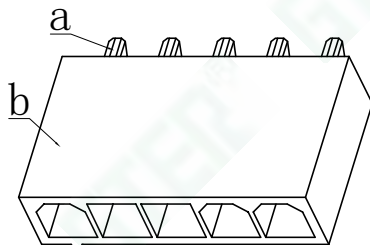
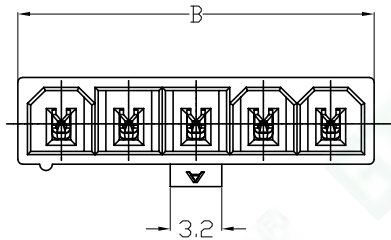

■ Main Specifications

- 接触电阻 (Contact resistance):  $\leq 20m\Omega$
- 绝缘电阻 (Insulation resistance):  $\geq 1000M\Omega$
- 额定电压 (Rated voltage): 300V AC DC
- 额定电流 (Rated current): 7.0A AC DC
- 耐电压 (Withstand Voltage): 1500V AC/minute
- 温度范围 (Temperature Range):  $-25^{\circ}C \sim +85^{\circ}C$

■ 产品编码简介: GJ-A4201WVD-\*\*-AON-hollow

① ② ③ ④ ⑤

1. 系列号;
2. 卧式插板针座;
3. Pin位数, 02PIN~06PIN;
4. AON-Nylon66 UL94V-0 (本色);  
A2N-Nylon66 UL94V-2 (本色);
5. hollow-空心PIN针。

■ 适配 GJ-A4201 SOCKET HOUSING SERIES.

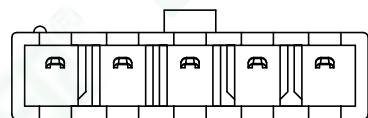
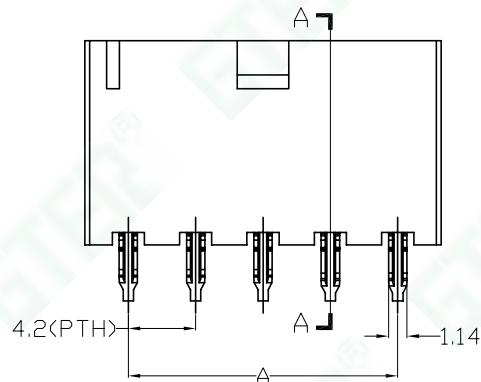
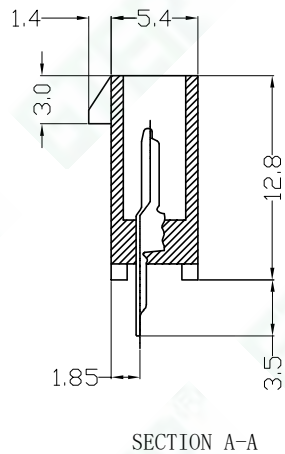

BACK VIEW

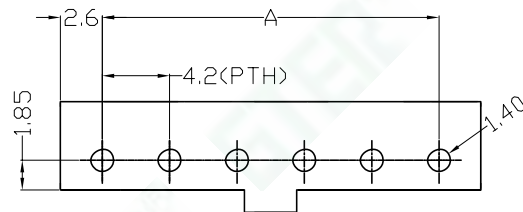

PCB LAYOUT

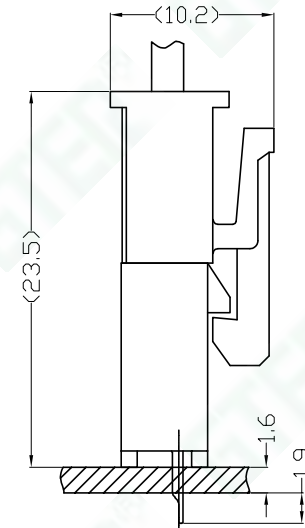

组成序号	名称	材质
a	1.14空心pin针	青铜镀亮锡
b	胶壳本体	Nylon66 (本色)

Poles	Dimensions(mm)		Q'ty/ bag
	A	B	
02P	4.20	9.60	1,000
03P	8.40	13.80	1,000
04P	12.60	18.00	1,000
05P	16.80	22.20	1,000
06P	21.00	26.40	1,000

**GTER**® 东莞市高嘉精密电子有限公司  
DONGGUAN GJ PRECISION ELECTRONICS Co.Ltd.

PART NO: GJ-A4201WVD-\*\*-\*\*\*-hollow

4.2mm WIRE TO BOARD CONNECTOR, SOCKET HOUSING

APPROVED BY: APPROVED

CHECKED BY: CHECKED

DRAWN BY: yiliangdong

DATE: 2022-11-21

A4201单排立插空心针产品图

PROJ:

UNIT: mm

SCALE: --

SHEET: 1/1 A4

VER NO: AO

TOLERANCE

-1 ±0.20

1-5 ±0.30

5-15 ±0.40

15-30 ±0.50

30- ±0.60

(ANGLE) .X ±10°

LTR

标记1

标记2

标记3

标记4

CUSTOMER: ---

REVISION RECORD

修改内容1

修改内容2

修改内容3

修改内容4

NAME

姓名1

姓名2

姓名3

姓名4

DATE

日期1

日期2

日期3

日期4

Conforms to The RoHS&REACH Instruction



5569

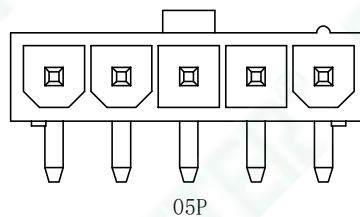
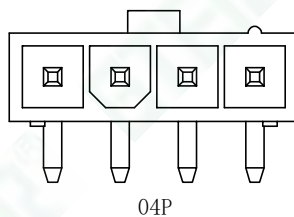
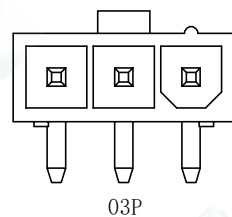
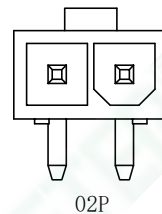
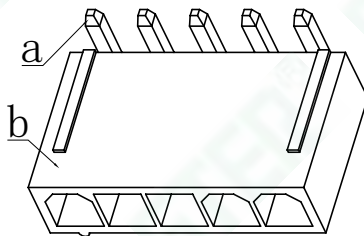
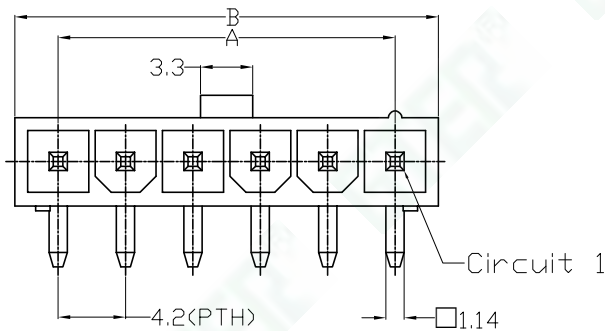

■ Main Specifications

- 接触电阻 (Contact resistance):  $\leq 20m\Omega$
- 绝缘电阻 (Insulation resistance):  $\geq 1000M\Omega$
- 额定电压 (Rated voltage): 300V AC DC
- 额定电流 (Rated current): 7.0A AC DC
- 耐电压 (Withstand Voltage): 1500V AC/minute
- 温度范围 (Temperature Range):  $-25^{\circ}C \sim +85^{\circ}C$

■ 产品编码简介: GJ-A4201WRD-\*\*-AON

1. 系列号; ① ② ③ ④
  2. 卧式插板针座;
  3. Pin位数, 02PIN~06PIN;
  4. AON-Nylon66 UL94V-0 (本色);  
A2N-Nylon66 UL94V-2 (本色);
- 适配 GJ-A4201 SOCKET HOUSING SERIES.

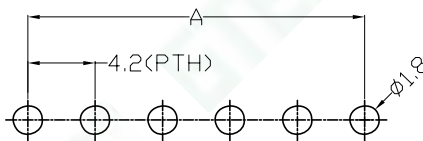
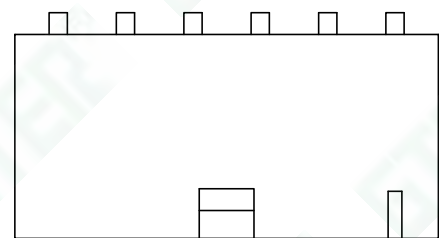
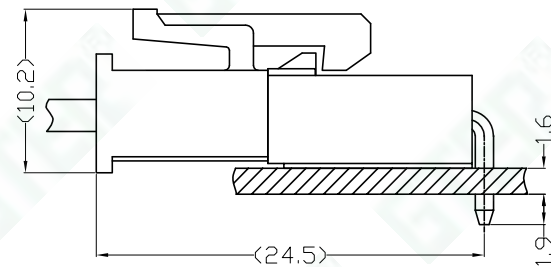
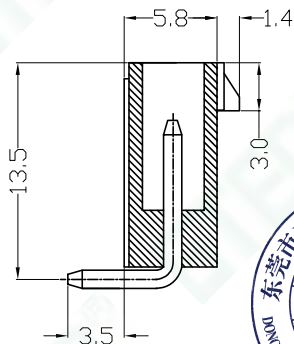
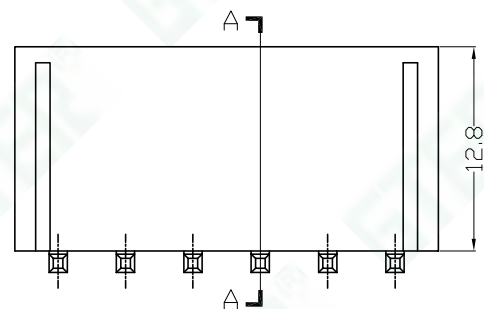

Poles	Dimensions(mm)		Q'ty/ bag
	A	B	
02P	4.20	9.60	1,000
03P	8.40	13.80	1,000
04P	12.60	18.00	1,000
05P	16.80	22.20	1,000
06P	21.00	26.40	1,000

组成序号	名称	材质
a	1.14方pin针	青铜镀亮锡
b	胶壳本体	Nylon66 (本色)

**GTER**® 东莞市高嘉精密电子有限公司  
DONGGUAN GJ PRECISION ELECTRONICS Co.Ltd.

PART NO: GJ-A4201WRD-\*\*-\*\*\*

4.2mm WIRE TO BOARD CONNECTOR, SOCKET HOUSING

APPROVED BY: APPROVED

CHECKED BY: CHECKED

DRAWN BY: yiliangdong

DATE: 2022-11-21

A4201单排卧插 产品图

PROJ:

UNIT: mm

SCALE: --

SHEET: 1/1 A4

VER NO: AO

TOLERANCE

-1 ±0.20

1-5 ±0.30

5-15 ±0.40

15-30 ±0.50

30- ±0.60

(ANGLE) .X ±10°

LTR

标记1

标记2

标记3

标记4

CUSTOMER: ---

REVISION RECORD

修改内容1

修改内容2

修改内容3

修改内容4

NAME

姓名1

姓名2

姓名3

姓名4

DATE

日期1

日期2

日期3

日期4

Conforms to The RoHS&REACH Instruction

5569

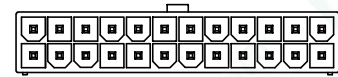
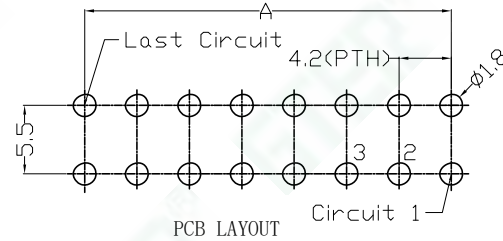
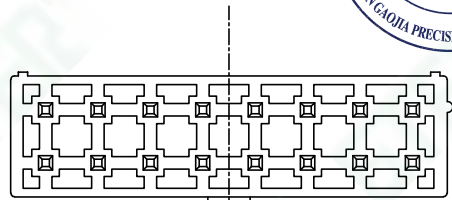
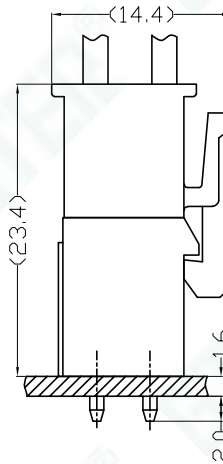
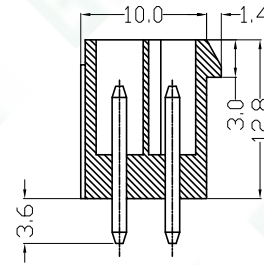
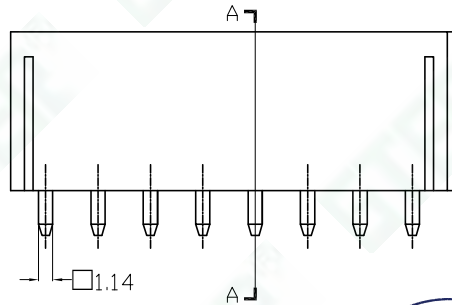
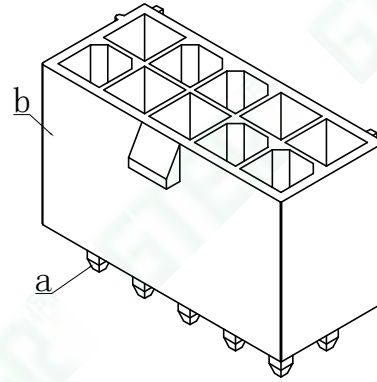
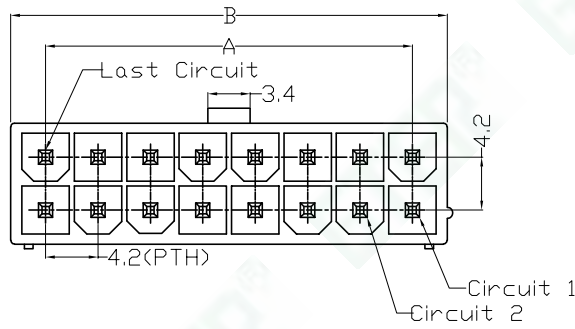

2x12P



2x01P

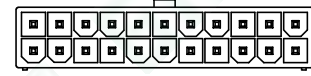

2x11P



2x02P

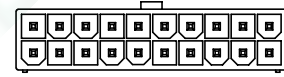

2x10P

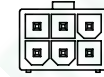

2x03P

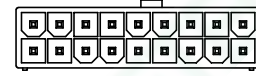

2x09P

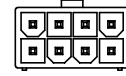

2x04P

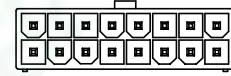

2x08P

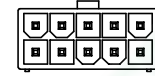

2x05P

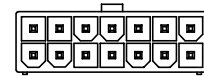

2x07P

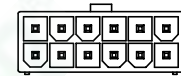

2x06P

■ Main Specifications

- 接触电阻 (Contact resistance):  $\leq 20m\Omega$
- 绝缘电阻 (Insulation resistance):  $\geq 1000M\Omega$
- 额定电压 (Rated voltage): 300V AC DC
- 额定电流 (Rated current): 7.0A AC DC
- 耐电压 (Withstand Voltage): 1500V AC/minute
- 温度范围 (Temperature Range):  $-25^{\circ}C \sim +85^{\circ}C$

■ 产品编码简介: GJ-A4201WVD-\*x\*\*-\*AON

1. 系列号;
  2. 立式插板针座;
  3. Pin位数, 2x01PIN~2x12PIN;
  4. AON-Ny1on66 UL94V-0 (本色);  
A2N-Ny1on66 UL94V-2 (本色);
- 适配 GJ-A4201 SOCKET HOUSING SERIES.

Poles	Dimensions(mm)		Q'ty/ bag
	A	B	
2x01P	—	5.60	1,000
2x02P	4.20	9.80	1,000
2x03P	8.40	14.00	1,000
2x04P	12.60	18.20	1,000
2x05P	16.80	22.40	1,000
2x06P	21.00	26.60	1,000
2x07P	25.20	30.80	1,000
2x08P	29.40	35.00	1,000
2x09P	33.60	39.20	1,000
2x10P	37.80	43.40	1,000
2x11P	42.00	47.60	1,000
2x12P	46.20	51.80	1,000

组成序号	名称	材质
a	1.14方pin针	青铜镀亮锡
b	胶壳本体	Nylon66 (本色)

**GTER**® 东莞市高嘉精密电子有限公司  
DONGGUAN GJ PRECISION ELECTRONICS Co.Ltd.

PART NO: GJ-A4201WVD-2x\*\*-\*

4.2mm WIRE TO BOARD CONNECTOR, SOCKET HOUSING

APPROVED BY: APPROVED

CHECKED BY: CHECKED

DRAWN BY: yiliangdong

DATE: 2022-11-21

A4201双排立插 产品图

PROJ:

UNIT: mm

SCALE: --

SHEET: 1/1 A4

VER NO: AO

TOLERANCE

-1 ±0.20

1-5 ±0.30

5-15 ±0.40

15-30 ±0.50

30- ±0.60

(ANGLE) .X ±10°

LTR

标记1

标记2

标记3

标记4

CUSTOMER: ---

REVISION RECORD

修改内容1

修改内容2

修改内容3

修改内容4

NAME DATE

姓名1 日期1

姓名2 日期2

姓名3 日期3

姓名4 日期4

Conforms to The RoHS&REACH Instruction



5569

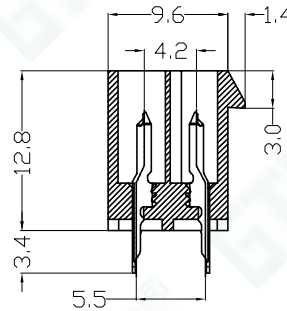
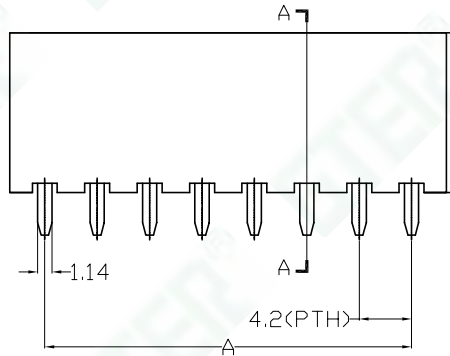
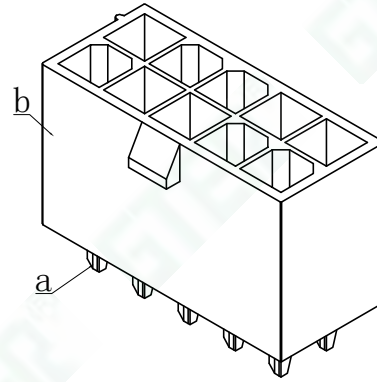
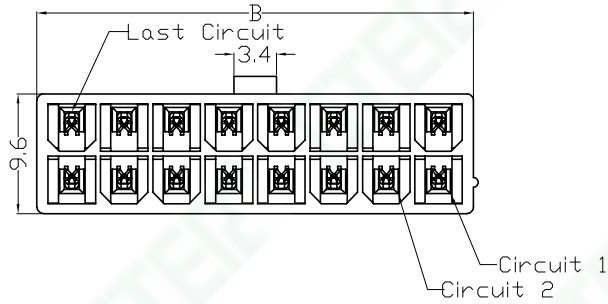

SECTION A-A

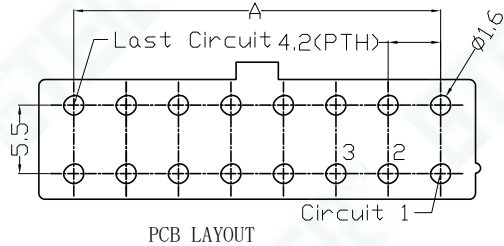

PCB LAYOUT

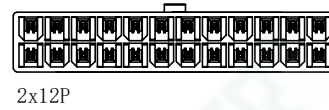
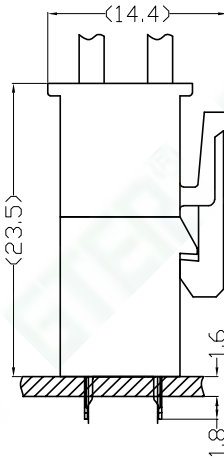

2x12P



2x01P



2x11P



2x02P



2x10P



2x03P



2x09P



2x04P



2x08P

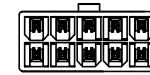

2x05P

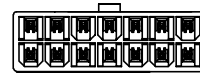

2x07P

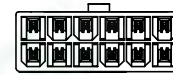

2x06P

■ Main Specifications

- 接触电阻 (Contact resistance):  $\leq 20m\Omega$
- 绝缘电阻 (Insulation resistance):  $\geq 1000M\Omega$
- 额定电压 (Rated voltage): 300V AC DC
- 额定电流 (Rated current): 7.0A AC DC
- 耐电压 (Withstand Voltage): 1500V AC/minute
- 温度范围 (Temperature Range):  $-25^{\circ}C \sim +85^{\circ}C$

■ 产品编码简介: GJ-A4201WVD-①x②PIN~③x④\*\*-AON-hollow

1. 系列号;
2. 立式插板针座;
3. Pin位数, 2x01PIN~2x12PIN;
4. AON-Nylon66 UL94V-0 (本色);  
A2N-Nylon66 UL94V-2 (本色);
5. hollow-空心PIN针。

■ 适配 GJ-A4201 SOCKET HOUSING SERIES.

Poles	Dimensions(mm)		Q'ty/ bag
	A	B	
2x01P	—	5.60	1,000
2x02P	4.20	9.80	1,000
2x03P	8.40	14.00	1,000
2x04P	12.60	18.20	1,000
2x05P	16.80	22.40	1,000
2x06P	21.00	26.60	1,000
2x07P	25.20	30.80	1,000
2x08P	29.40	35.00	1,000
2x09P	33.60	39.20	1,000
2x10P	37.80	43.40	1,000
2x11P	42.00	47.60	1,000
2x12P	46.20	51.80	1,000

组成序号	名称	材质
a	1.14空心pin针	青铜镀亮锡
b	胶壳本体	Nylon66 (本色)

**GTER**® 东莞市高嘉精密电子有限公司  
DONGGUAN GJ PRECISION ELECTRONICS Co.Ltd.

PART NO: GJ-A4201WVD-2x\*\*-\*\*\*-hollow

4.2mm WIRE TO BOARD CONNECTOR, SOCKET HOUSING

APPROVED BY: APPROVED

CHECKED BY: CHECKED

DRAWN BY: yiliangdong

DATE: 2022-11-21

A4201双排立插空心针产品图

PROJ:

UNIT: mm

SCALE: --

SHEET: 1/1 A4

VER NO: AO

TOLERANCE

-1 ±0.20

1-5 ±0.30

5-15 ±0.40

15-30 ±0.50

30- ±0.60

(ANGLE) .X ±10°

LTR

标记1

标记2

标记3

标记4

CUSTOMER: ---

REVISION RECORD

修改内容1

修改内容2

修改内容3

修改内容4

NAME

姓名1

姓名2

姓名3

姓名4

DATE

日期1

日期2

日期3

日期4

Conforms to The RoHS&REACH Instruction

5569

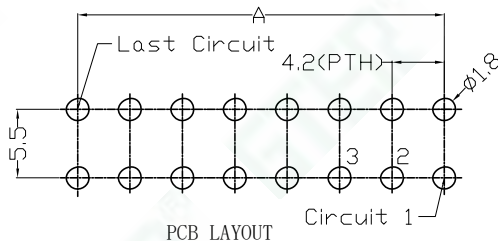
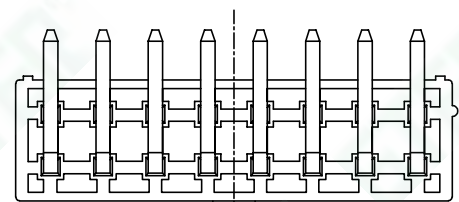
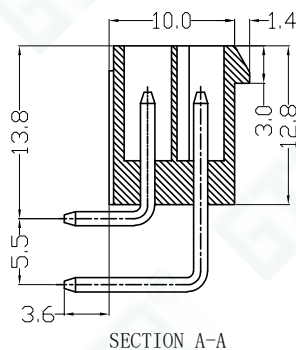
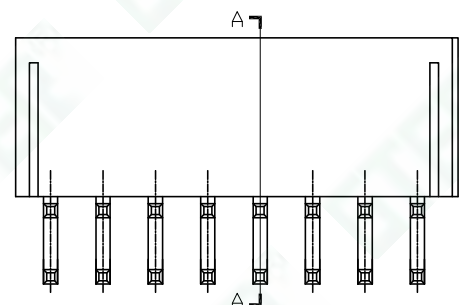
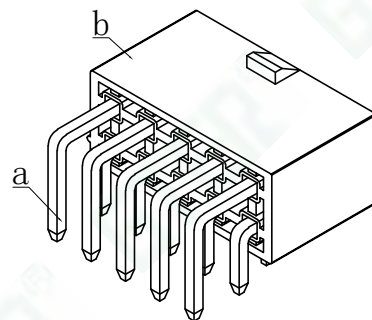
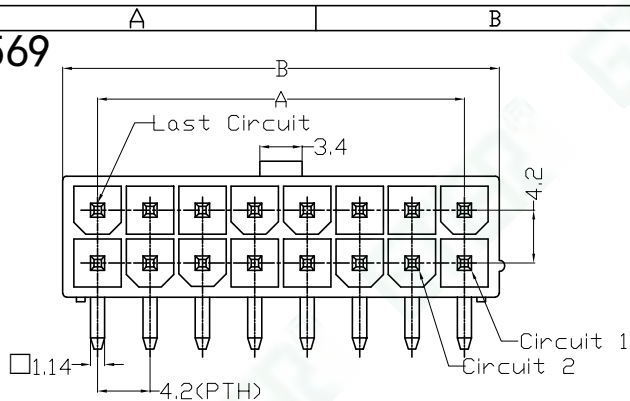

■ Main Specifications

- 接触电阻 (Contact resistance):  $\leq 20m\Omega$
- 绝缘电阻 (Insulation resistance):  $\geq 1000M\Omega$
- 额定电压 (Rated voltage): 300V AC DC
- 额定电流 (Rated current): 7.0A AC DC
- 耐电压 (Withstand Voltage): 1500V AC/minute
- 温度范围 (Temperature Range):  $-25^{\circ}C \sim +85^{\circ}C$

■ 产品编码简介: GJ-A4201WRD-x\*\*-AON

1. 系列号; ① ② ③ ④
2. 卧式插板针座;
3. Pin位数, 2x01PIN~2x12PIN;
4. AON-Ny1on66 UL94V-0 (本色);  
A2N-Ny1on66 UL94V-2 (本色);

■ 适配 GJ-A4201 SOCKET HOUSING SERIES.

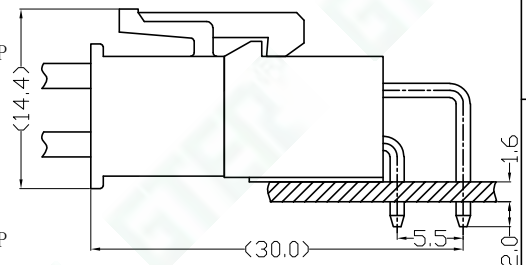
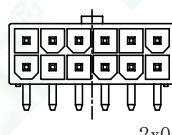
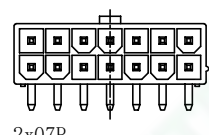
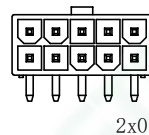
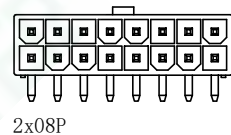
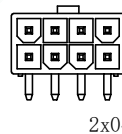
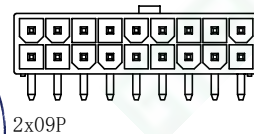
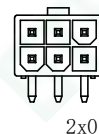
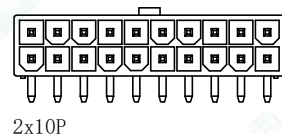
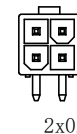
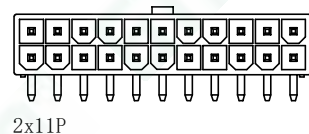
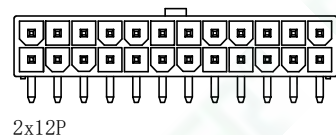

Poles	Dimensions(mm)		Q'ty/ bag
	A	B	
2x01P	—	5.60	1,000
2x02P	4.20	9.80	1,000
2x03P	8.40	14.00	1,000
2x04P	12.60	18.20	1,000
2x05P	16.80	22.40	1,000
2x06P	21.00	26.60	1,000
2x07P	25.20	30.80	1,000
2x08P	29.40	35.00	1,000
2x09P	33.60	39.20	1,000
2x10P	37.80	43.40	1,000
2x11P	42.00	47.60	1,000
2x12P	46.20	51.80	1,000

组成序号	名称	材质
a	1.14方pin针	青铜镀亮锡
b	胶壳本体	Nylon66 (本色)

**GTER**® 东莞市高嘉精密电子有限公司  
DONGGUAN GJ PRECISION ELECTRONICS Co.Ltd.

PART NO: GJ-A4201WRD-2x\*\*-\*\*\*

4.2mm WIRE TO BOARD CONNECTOR, SOCKET HOUSING

APPROVED BY: APPROVED

CHECKED BY: CHECKED

DRAWN BY: yiliangdong

DATE: 2022-11-21

A4201双排卧插 产品图

PROJ:

UNIT: mm

SCALE: --

SHEET: 1/1 A4

VER NO: AO

TOLERANCE

-1 ±0.20

1-5 ±0.30

5-15 ±0.40

15-30 ±0.50

30- ±0.60

(ANGLE) .X ±10°

LTR

标记1

标记2

标记3

标记4

CUSTOMER: ---

REVISION RECORD

修改内容1

修改内容2

修改内容3

修改内容4

NAME

姓名1

姓名2

姓名3

姓名4

DATE

日期1

日期2

日期3

日期4

Conforms to The RoHS&REACH Instruction

5569

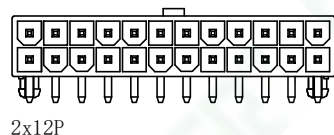
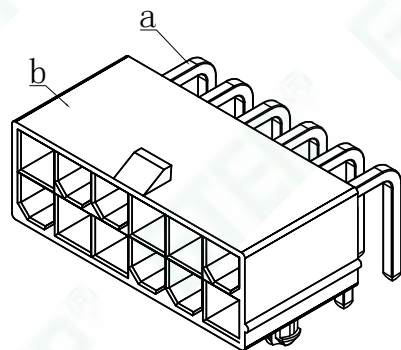
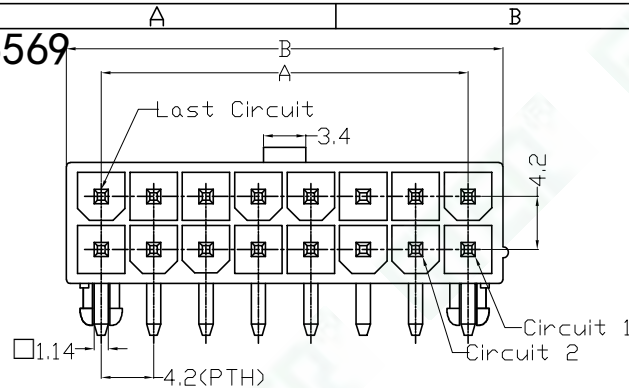

2x12P



2x01P



2x11P

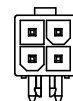

2x02P

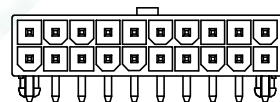

2x10P

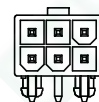

2x03P

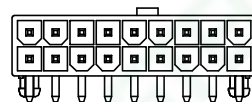

2x09P

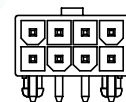

2x04P

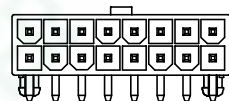

2x08P

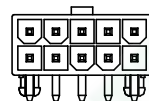

2x05P

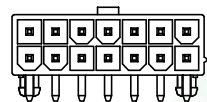

2x07P

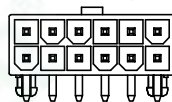

2x06P

■ Main Specifications

- 接触电阻 (Contact resistance):  $\leq 20m\Omega$
- 绝缘电阻 (Insulation resistance):  $\geq 1000M\Omega$
- 额定电压 (Rated voltage): 300V AC DC
- 额定电流 (Rated current): 7.0A AC DC
- 耐电压 (Withstand Voltage): 1500V AC/minute
- 温度范围 (Temperature Range):  $-25^{\circ}C \sim +85^{\circ}C$

■ 产品编码简介: GJ-A4201WRD-①\*②\*\*③-A0N-P ④⑤

1. 系列号;
2. 卧式插板插座;
3. Pin位数, 2x01PIN~2x12PIN;
4. A0N-Nylon66 UL94V-0 (本色);  
A2N-Nylon66 UL94V-2 (本色);
5. 带定位柱;

■ 适配 GJ-A4201 SOCKET HOUSING SERIES.

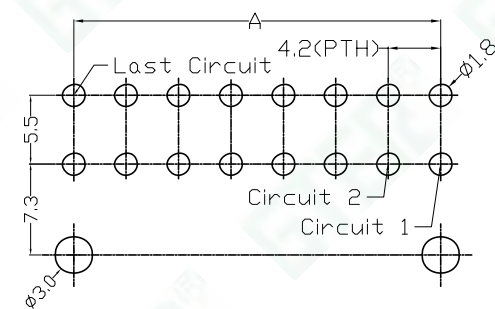
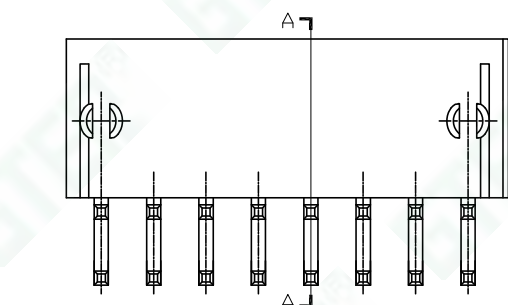
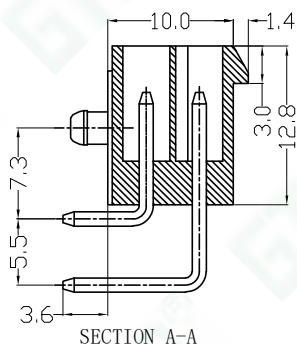
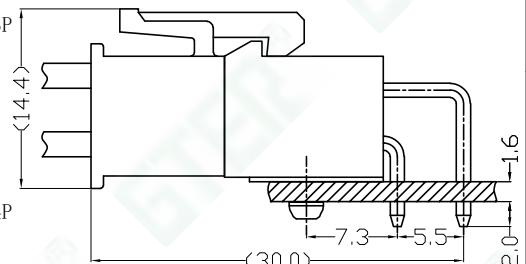

2x03P-2x12P PCB LAYOUT

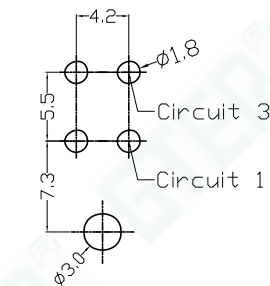

2x02P PCB LAYOUT

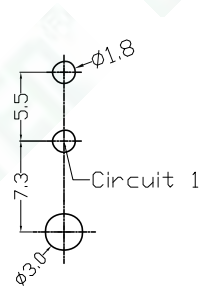

2x01P PCB LAYOUT

Poles	Dimensions(mm)		Q'ty/ bag
	A	B	
2x01P	—	5.60	1,000
2x02P	4.20	9.80	1,000
2x03P	8.40	14.00	1,000
2x04P	12.60	18.20	1,000
2x05P	16.80	22.40	1,000
2x06P	21.00	26.60	1,000
2x07P	25.20	30.80	1,000
2x08P	29.40	35.00	1,000
2x09P	33.60	39.20	1,000
2x10P	37.80	43.40	1,000
2x11P	42.00	47.60	1,000
2x12P	46.20	51.80	1,000

组成序号	名称	材质
a	1.14方pin针	青铜镀亮锡
b	胶壳本体	Nylon66 (本色)

**GTER**® 东莞市高嘉精密电子有限公司  
DONGGUAN GJ PRECISION ELECTRONICS Co.Ltd.

PART NO: GJ-A4201WRD-2x\*\*-\*\*\*-P

4.2mm WIRE TO BOARD CONNECTOR, SOCKET HOUSING

APPROVED BY: APPROVED  
CHECKED BY: CHECKED  
DRAWN BY: yiliangdong  
DATE: 2022-11-21  
A4201双排卧式插带定位柱产品图

PROJ:   
UNIT: mm  
SCALE: --  
SHEET: 1/1 A4  
VER NO: AO

TOLERANCE  
-1 ±0.20  
1-5 ±0.30  
5-15 ±0.40  
15-30 ±0.50  
30- ±0.60  
(ANGLE) .X ±10°

LTR  
标记1 修改内容1  
标记2 修改内容2  
标记3 修改内容3  
标记4 修改内容4  
CUSTOMER: ---

REVISION RECORD  
NAME  
DATE  
姓名1 日期1  
姓名2 日期2  
姓名3 日期3  
姓名4 日期4  
Conforms to The RoHS&REACH Instruction